

Simulation

MANAGER

1/2022



FlexSim is in the game

An interview with professor Krzysztof Nowosielski

Digital twin of an innovative process line at Valmont Poland

Piotr Sender, chief computer simulation engineer at Valmont Polska LLC

PAGE 11

Study of the effect of buffer capacity increase on filling line throughput

Dawid Dąbal, vice president, FlexSim program director at InterMarium LLC

PAGE 15

Creating digital twins in the internal logistics industry

Wojciech Skwira, director of the internal logistics section, MPL TECHMA LLC

PAGE 20

SIMULATION ACADEMY

Simulation Project of the Year

**Win 1 of
3 prizes
worth
€1,000
each**

**Submit your
model by the
end of the
year**

FIND OUT MORE:



The campaign is aimed at:

**simulation engineers
process engineers
graduates
students**



INTERMARIUM
FUNDACJA

ORGANIZER:

INTERMARIUM Foundation
Aleja Pokoju 1
31-548 Kraków

From the editor

Dear readers,

We are starting a new chapter for the community of simulation modeling and process analysis enthusiasts.

We are extremely pleased to present you with the first issue of our magazine. We have created it for the elite of business and industry, science, public and local government sectors - that is, for you. This would not be possible without your support, as we have been privileged to create and develop this unusual phenomenon in Central and Eastern Europe - a community of enthusiasts of simulation modeling and analysis in the FlexSim environment. In order to grow it gradually wider, and at the same time contribute to the accomplishment of your business goals, we are taking up this call.

FlexSim is an innovative computer program with exceptional analytical capabilities that can quickly process as many experiments, optimizations and simulations as you need so that you can make the most favorable business decisions and get the best possible results.

In these times of turmoil, we write to you from Aleja Pokoju 1 in Kraków, Poland, where FlexSim InterMarium is headquartered. From here, we would like to promote the belief that there can be peace and prosperity in the Intermarium, as well as in the world as a whole, and that it will arise as a result of the goodwill, effort, and work of people striving for excellence.

What do we want to share with you in the first issue of our magazine? In addition to important content about the new capabilities of our software described by Dawid Dąbal in "What's new in FlexSim?", you will find valuable examples of applications of FlexSim in industry in the "Case studies" section. We also recommend the interview with Professor Krzysztof Nowosielski, who talks about how he managed to create the modern Business Process Simulation Center at Wrocław University of Economics and Business. In addition, the pages of "Simulation Manager" magazine, you will also read a column about why FlexSim is all about people. There is also a bit of information about the most interesting recent events for the simulation-driven optimization

community, as well as about those for which we are making plans and would already like to invite you to join in their preparation and implementation. We present a textbook on simulation modeling authored by Krzysztof Jurczyk that will be a breakthrough in the Polish publishing market and showcase the Office of Simulation Projects, which he has the pleasure to lead. In addition, Patryk Żuchowicz will introduce you to simulation games, and Krystian Kogut will talk about the Simulation Academy. He will also acquaint you with our "after hours" project with the proud name of "In Solidarity for the Future". Finally, to add a bit of levity to the content, we have also created a "SimuLatte" corner for you, with cartoon humor to provide entertainment during a coffee break.

Getting from the idea for this magazine to its release proved to be quite a challenge. First, the saying that "Every idea seems great until it is tried" proved true. Then we turned to the motto of the famous composer Leonard Bernstein: "To accomplish great works, two things are necessary: a plan and not enough time." A good plan saved us because we had really little time... Therefore, we ask for your forbearance, but do not refrain from constructive criticism. We are committed to making this magazine better and better.

We hope that this will be a good start, and already in this issue, you will find interesting and inspiring content.

We ask for letters with opinions, suggestions, and comments. We will try to include the most interesting ones in the next issues.

We invite everyone to contribute to the magazine. Send your observations to: editor@simulationmanager.online.

Our mission will be fulfilled if you come at least a little closer to realizing the maxim:

The more you read, learn, discuss and experiment, the more probable it is that you will come across an idea, which combined with your capabilities and resources will lead you to great success in your field.

(Brian Tracy)

We wish you an inspiring reading experience!



Witold A. Cempel, PhD
the editor of *Simulation Manager*



Natalia Witkowska-Cempel
the editor of *Simulation Manager*

Publisher InterMarium LLC & INTERMARIUM Foundation
Aleja Pokoju 1
31-548 Kraków

Editors: Natalia Witkowska-Cempel, Witold Aleksander Cempel
e-mail to editors: editor@simulationmanager.online
English translator: Przemysław Pasich

English proofreading: Markus Cueva
Polish language proofreading: Karolina Klinowska
Editing of texts in Polish: Elżbieta Krok
Place and date of publication: Kraków, September 2022
ISSN: 4300-6452
Current numbering: 01/2022

CONTENT

08

05



WHAT'S NEW IN FLEXSIM?

New features and quality of life improvements

- GIS (Geographic Information System)
- Reinforcement Learning
- Enhanced Experimenter tool
- Python Connector
- Range-based experimenter jobs
- A* improvements
- Mass Flow Conveyor

Dawid Dąbal, vice president, FlexSim program director at InterMarium LLC

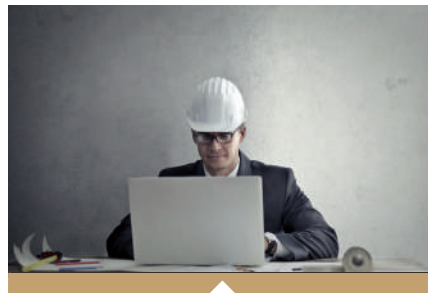

CASE STUDIES

Digital twin of an innovative process line at Valmont Poland

As the maxim goes: don't bring an opinion to a data fight - the numbers speak for themselves

Piotr Sender, chief computer simulation engineer at Valmont Polska LLC

Study of the effect of buffer capacity increase on filling line throughput

How to remedy the difficulty of analyzing a high volume production line with high variability?

Dawid Dąbal, vice president, FlexSim program director at InterMarium LLC

Optimization of production batch size

Find out how long it takes to create a model to determine the optimal batch size for a production line

Dawid Dąbal, vice president, FlexSim program director at InterMarium LLC

Creating digital twins in the internal logistics industry

When creating transportation systems for the warehousing we can use simulation to visualize the process and related operations even before the project is implemented

Wojciech Skwira, director of the internal logistics section, MPL TECHMA LLC

12



LEADER

FlexSim is in the game at Wrocław University of Economics and Business!

An interview with professor Krzysztof Nowosielski

Krzysztof Nowosielski, PhD originator and manager of Business Process Simulation Center (BPSC) at Wrocław University of Economics and Business (WUEB)



COLUMN

FlexSim is first and foremost about people

Condensed reflections

Witold Aleksander Cempel, PhD
the president of InterMarium LLC



RECENT EVENTS

See how we are changing the world for the better!

Optimization and Simulation Engineer of WSB University

Production Engineering and Management at the Silesian University of Technology

Opening ceremony of the hub4industry showroom

FlexSim InterMarium at INTARG

FlexSim InterMarium at Logistic and Warehouse Trends conference

The opening of the Business Process Simulation Center at Wroclaw University of Economics and Business

The Smart Production Lab Network at Kielce University of Technology

Social Council at Silesian University of Technology

And more inside the article.



EXPLORE THE COUNTRIES OF THE INTERMARIUM

In Solidarity for the Future

The person will be the most important!

Krystian Kogut, board member of the INTERMARIUM Foundation

14

17



SIMULATTE

Let's have a laugh!

Humor drawing by FlexSim software community and enthusiasts

Zbigniew Polit, satirist

Rafał Cempel, a young satirist

Przemysław Pasich, simulation engineer at InterMarium LLC



ANNOUNCEMENTS

Intermarium Simulation Conference 2022
Business Missions – Central & Eastern Europe 2023
Business Missions – Poland 2023

23



NOVELTY SHOWCASE

Process improvement simpler than you think

Simulation project bureau

Krzysztof Jurczyk, director of operations at InterMarium LLC

FlexSim. User manual Simulation

Academy - Simulation Project of the Year competition

Krystian Kogut, international sales director at InterMarium LLC

Simulation games

Krzysztof Jurczyk, director of operations at InterMarium LLC

Patryk Żuchowicz, senior simulation engineer at InterMarium LLC

New features and quality of life improvements

DAWID DĄBAL

vice president, FlexSim program director
at InterMarium LLC

During the last year a few novel functionalities were introduced:

GIS (Geographic Information System) module

The GIS module is powerful for modeling supply chains, inter-logistics, and any other transportation uses where travel time and covered distance are a factor. It lets users both accurately simulate travel and visualize the movement of the transports on the map and – most importantly – it comes pre-configured to automatically route paths across road networks around the world.

The module comprises two objects:

- Map – it displays a map in the 3D view that can be moved, zoomed, panned.
- Point – it is placed on the Map object and it's used in a similar way as a Network Node;

users can make a connection between points and the GIS module will automatically calculate a path between two points using available roads (Driving Roads connection type), air routes (Flight Paths) or just in a straight line. The points can be assigned one of the predefined shapes – factory, warehouse, port, airport and railyard.

The paths between points can be further customized by adding average speeds or associating costs with them. The logic of charting paths can also be changed in GIS Navigator Properties.

Reinforcement Learning

The Reinforcement Learning tool combines the interface, files, and documentation you will need to use a FlexSim model as an environment for training and evaluating reinforcement learning

We would like to share with you information about the new modules and features introduced between version 2021 and version 2022 Update 1. These are not only real game-changers but also visionary improvements

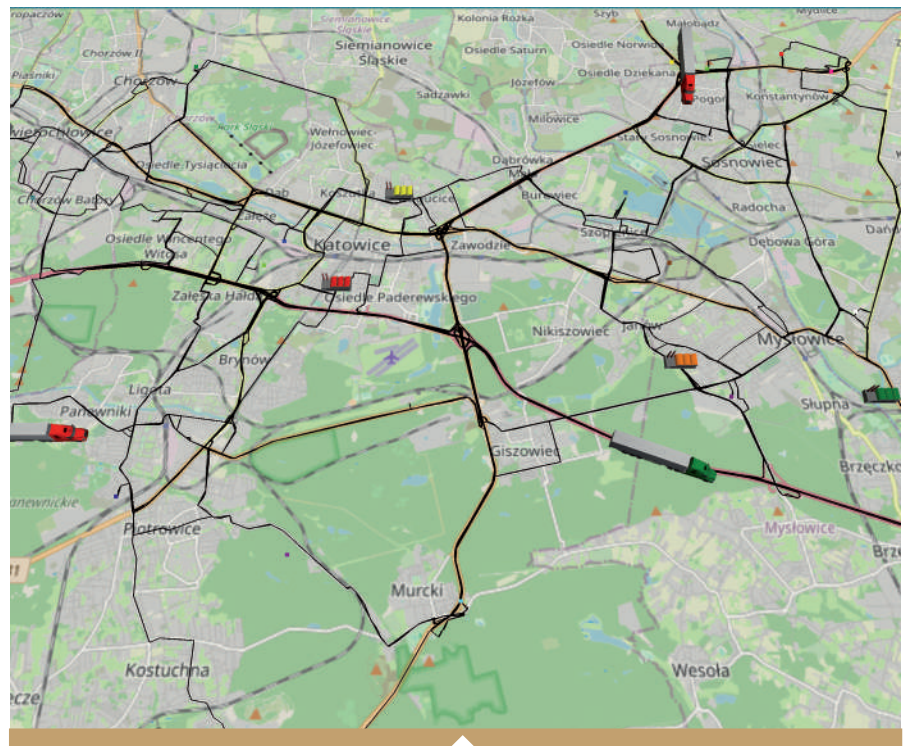

Fig. 1. GIS network set up for the Katowice urban area.

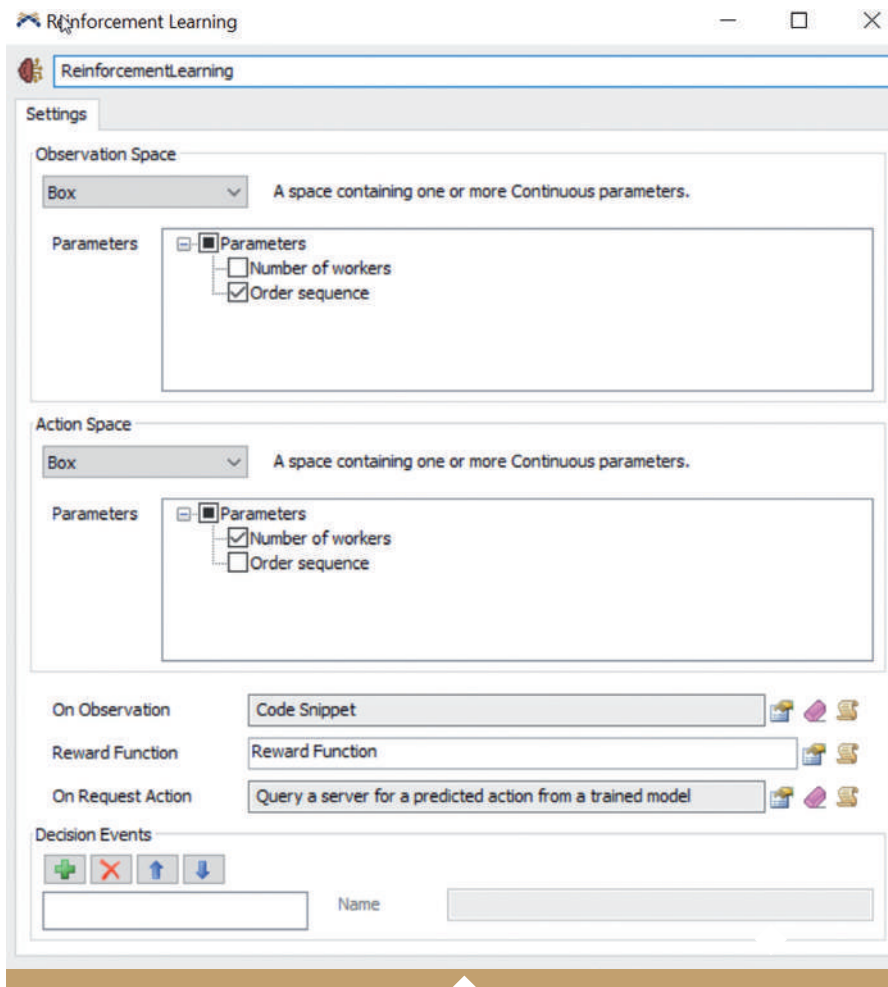

Fig. 2. Reinforcement Learning interface.

algorithms. This tool gives users the ability to communicate learning algorithms with FlexSim. This simple yet powerful interface allows for both training the algorithm and using already AI-trained simulation models in a real production environment. Modelers can easily set up observations/actions, add a reward function and specify decision events. A reinforcement learning episode typically consists of an agent making an observation of the environment, taking an action in response to the observation, receiving a reward, and then continuing to observe, take actions, and receive rewards in a cycle until the episode is done.

The agent usually begins by taking random actions (exploration). As the agent receives rewards, it learns to maximize those rewards by taking more optimal actions based on what it has learned (exploitation). The reward for a given action may not be immediate. For example, if you take a wrong turn in a maze, you won't know until you hit a dead end. Reinforcement learning algorithms account for this delayed reward in different ways, but they each follow the same basic flow even when a reward may not be directly related to the most recent action.

There is a complete tutorial about reinforcement

learning in FlexSim documentation. It contains some pre-built algorithms that can be used to minimize changeover times.

Enhanced Experimenter tool

The Experimenter tool was almost completely rebuilt. The Scenarios tab has been redesigned and renamed Jobs – from now on this will be the term used in FlexSim when discussing simulation experiments. Each Job represents the parameters and scenarios that make up the experiment, whether it's a normal simulation experiment or an optimization using the OptQuest add-on. Users can now create multiple experiments (Jobs) in one simulation model.

Another change is how Experimenter handles experiment results: the data is now saved in a SQLite database file. By default, it has the same name as the model file and is saved in the same directory. Thanks to this, the simulation model does not use RAM to store results. In consequence, the users can solve much bigger problems because the amount of system resources needed is greatly reduced. Additionally, the model file size becomes smaller. This approach also brings many quality of life features for experimentation. Users no longer need to

re-run every replication each time they change the experiment. If more scenarios and replications are added, they will be added as proposed replications alongside the already completed ones – to be completed with the next batch. User can also re-run only a chosen replication in case there are some problems or bugs for a given set of parameters – the model can set up according to these parameters using convenient "Test tube" buttons in case a more detailed look is needed.

Python Connector

FlexSim users can now call Python packages and scripts. This is an appreciable expansion to FlexSim functionality considering the vast Python libraries for machine learning and AI. Additionally, FlexSim developers added a custom module so Python can load FlexSim into its process and then execute FlexSim directly. This means you can now control FlexSim from an external location by directly calling functions in FlexSim using Python.

Range-based experimenter jobs

This new addition to Experimenter tool is perfect for users that would like to try many combinations of parameter values in an experiment. The job will iterate on all possible values for each parameter or on specific values for the given parameter. Range-Based Experimenter job will automatically create all the different scenario combinations to run and evaluate. That will save significant time over manually setting up every possible combination.

A* improvements

The biggest changes in A* are the ability to have oblong node sizes with strict diagonals (the travelers can only travel along X and Y axis) and to dynamically add and remove barriers in an A* grid. This allows modelers to build more complex models of the AGV systems (for example Kiva system), in which an AGV that is empty can travel anywhere, but once it's loaded with an item, it must travel in the through lanes.

Mass Flow Conveyor

FlexSim users can now simulate the flow of high volumes of units with much less work thanks to this object added to the Conveyors library. It will be especially useful in food and bulk good manufacturing, bottling and any other high speed/volume manufacturing. The mass flow conveyor uses fluid-based modeling to calculate unit density and maximum possible flow rate. Thanks to this approach, it reduces the amount of computing power needed and also ensures great visualization of the flow.

Some minor features have also been introduced:

AGV Route Cost – users can now specify Route Cost options from the General tab of AGV Network Properties. FlexSim can now choose a route that is

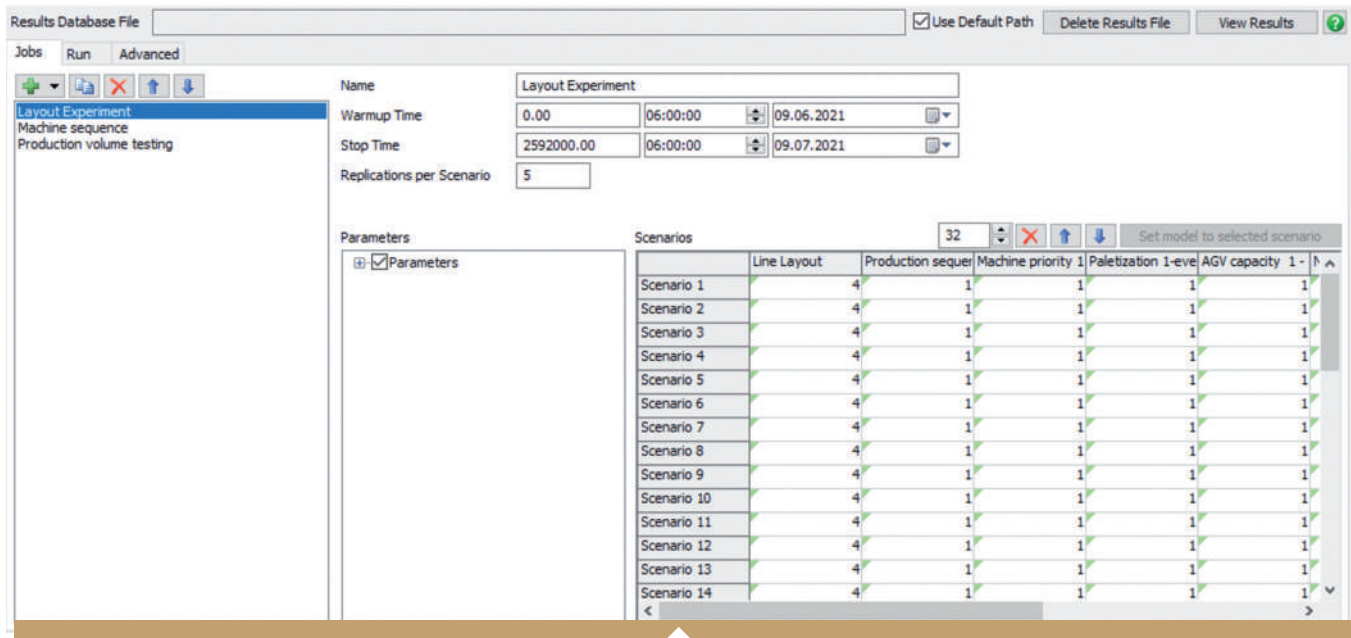

Fig. 3. Experimenter interface.

the shortest, the fastest, or the one that minimizes a custom cost function.

AGV Conditional Rules – users can create conditional rules in AGV Network Properties tab for closing/opening paths.

Floors properties panel – the new Floor tab can be found in 3D View's Properties panel and it contains a simple interface to manage model floors. Users can now change the grid positions, floor's height, lock objects onto specific floors and change the visibility of all objects on a given floor.

Entry/Exit Transfer arrows – FlexSim users will no longer confuse Entry and Exit transfers on conveyors: Entry transfers will have an arrow that points

toward the conveyor and Exit transfers will have an arrow that points away from it.

Improved Crane manipulation – Crane object now includes an additional set of manipulation handles to easily change its height, width, and length. There is also a Size field in its properties to edit the size of its elements (columns, rails, etc.) in greater detail.

State Tables – this is a new way to handle custom object states. Users can now easily add new states to better describe resource utilization.

Fork movement for forklift/transporter – a checkbox "Allow Fork Movement During Travel" has been added to the Transporter tab of the

Transporter Object. Now users have an option to force a forklift to stop before raising or lowering its forks.

Frustum culling – if this option for an object is checked, it will not be rendered as long as its bounding box is outside of the view frustum (the region of the model that appears on the screen). This is a useful option for big models to improve their performance.

OnSimulationStartEvent – this is an addition to the existing OnReset trigger that runs logic before model run.



Fig. 4. Python logo.

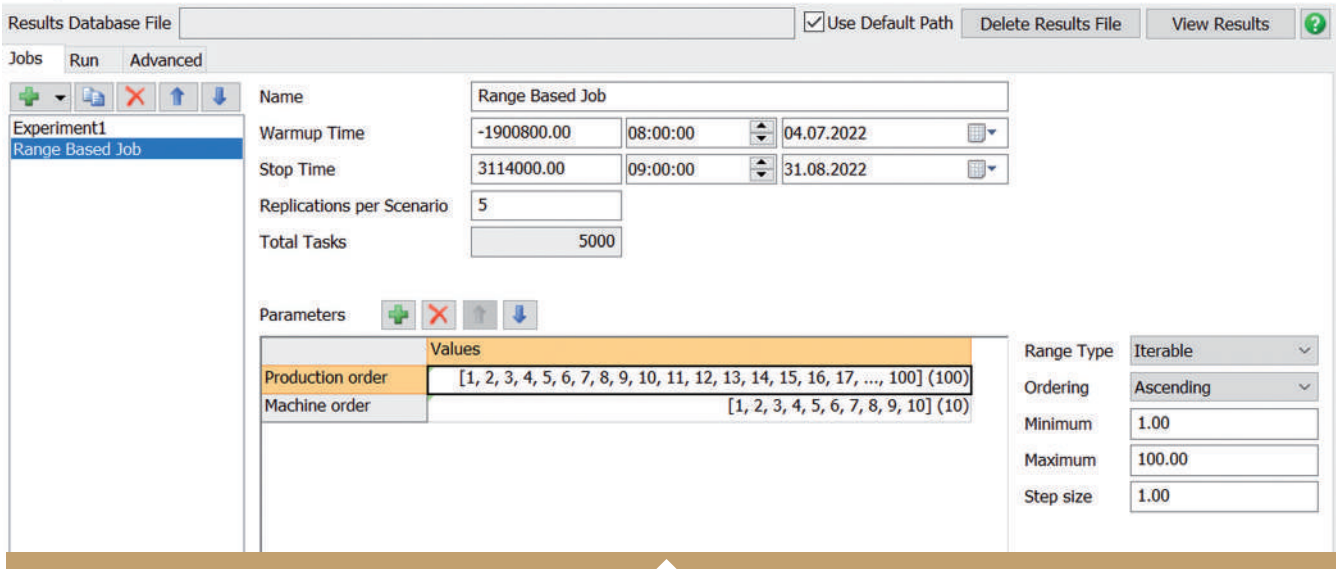

Fig. 5. Experimenter with a Range Based Job set up.



Fig. 6. A path exclusively along the X- and Y- axes.

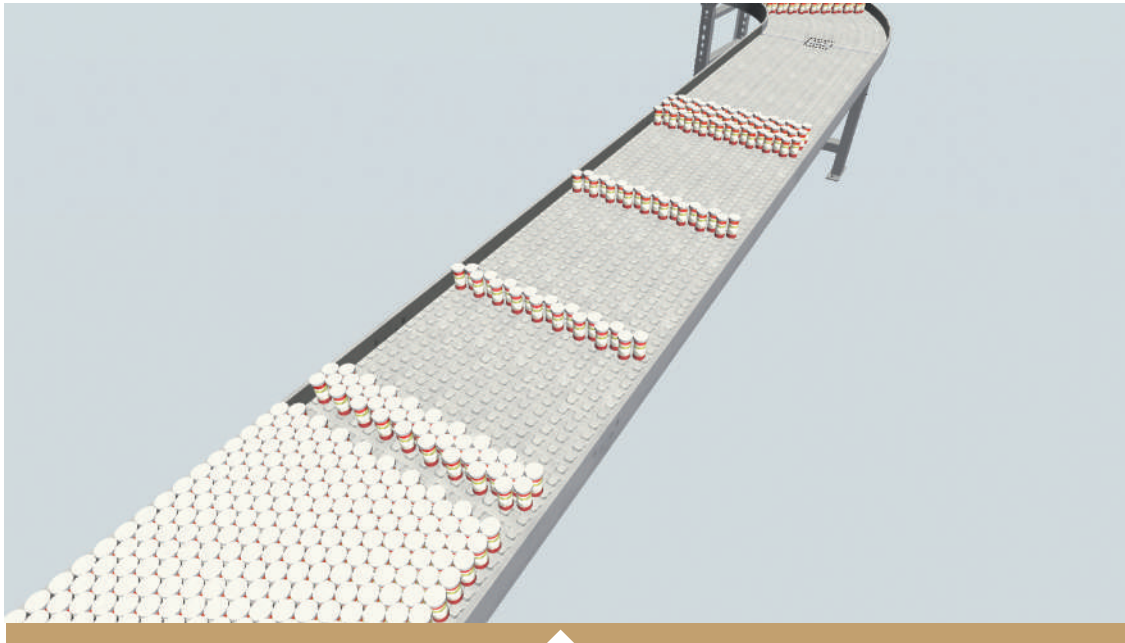

Fig. 7. Mass flow conveyor

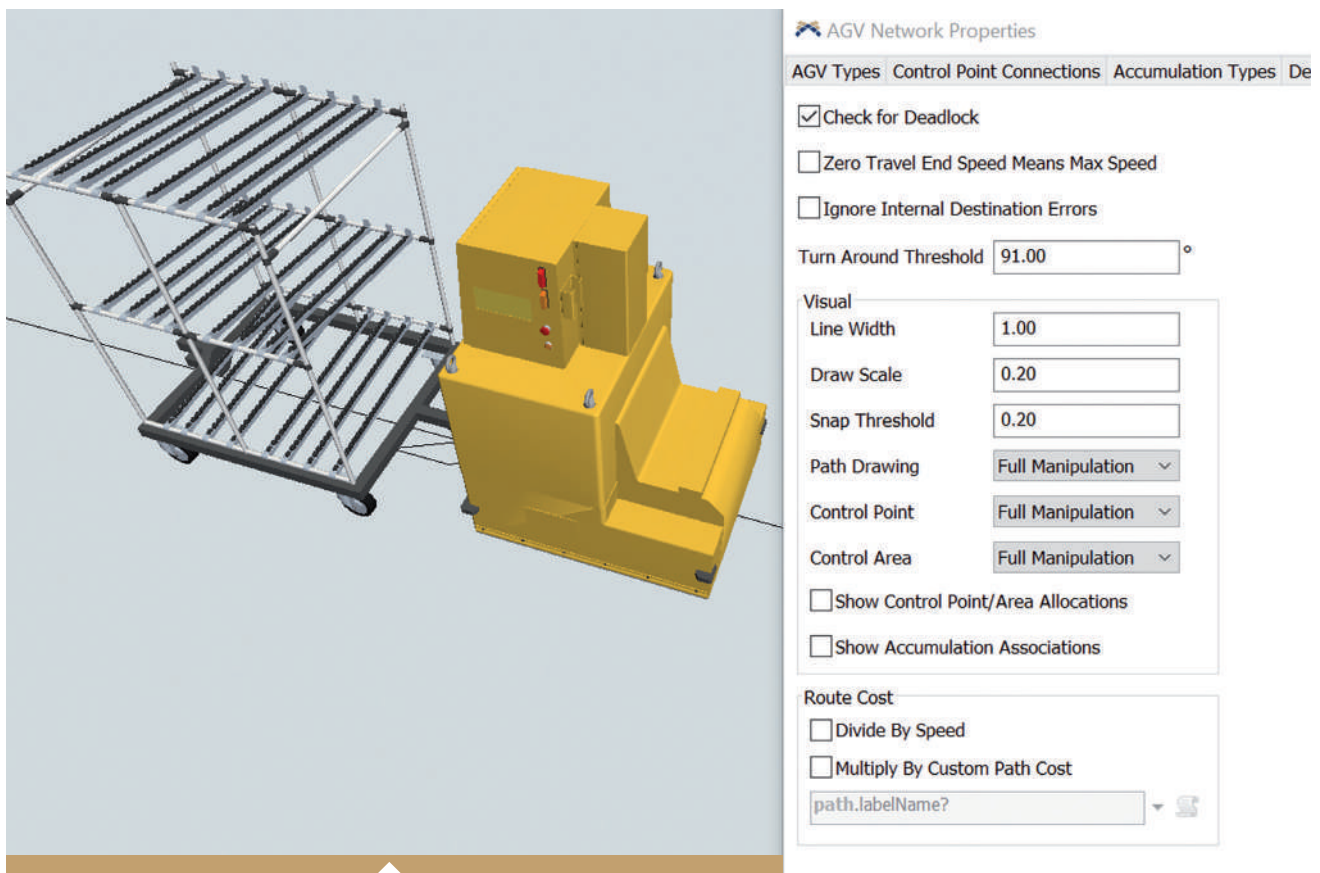

Fig. 8 Network properties window of an AGV.

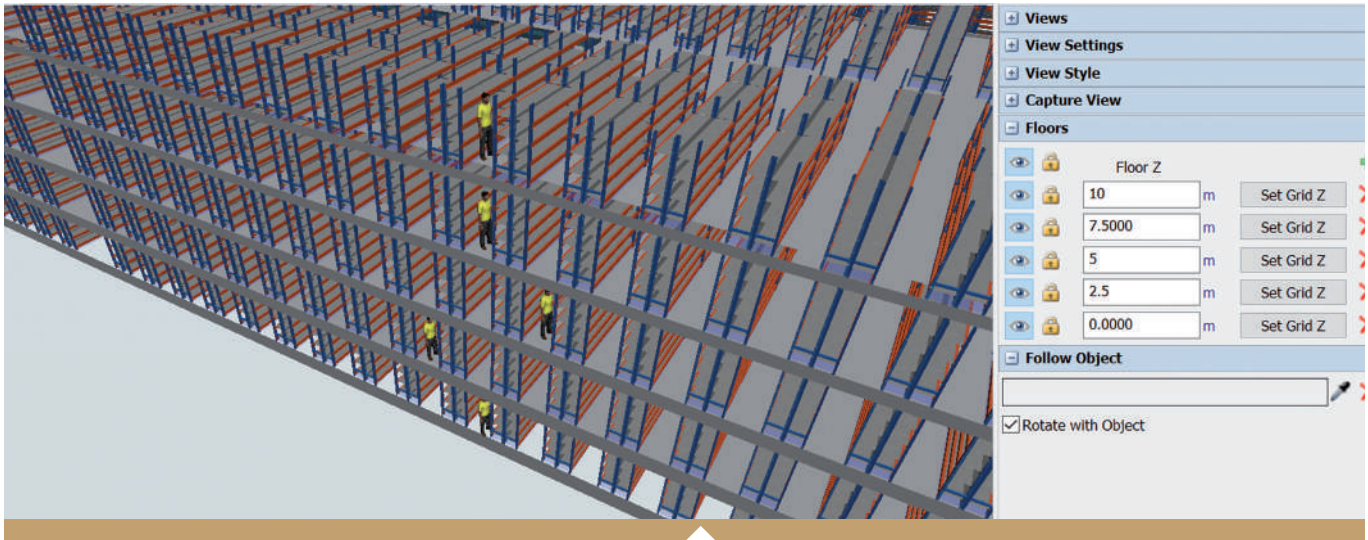

Fig. 9. Floors panel.

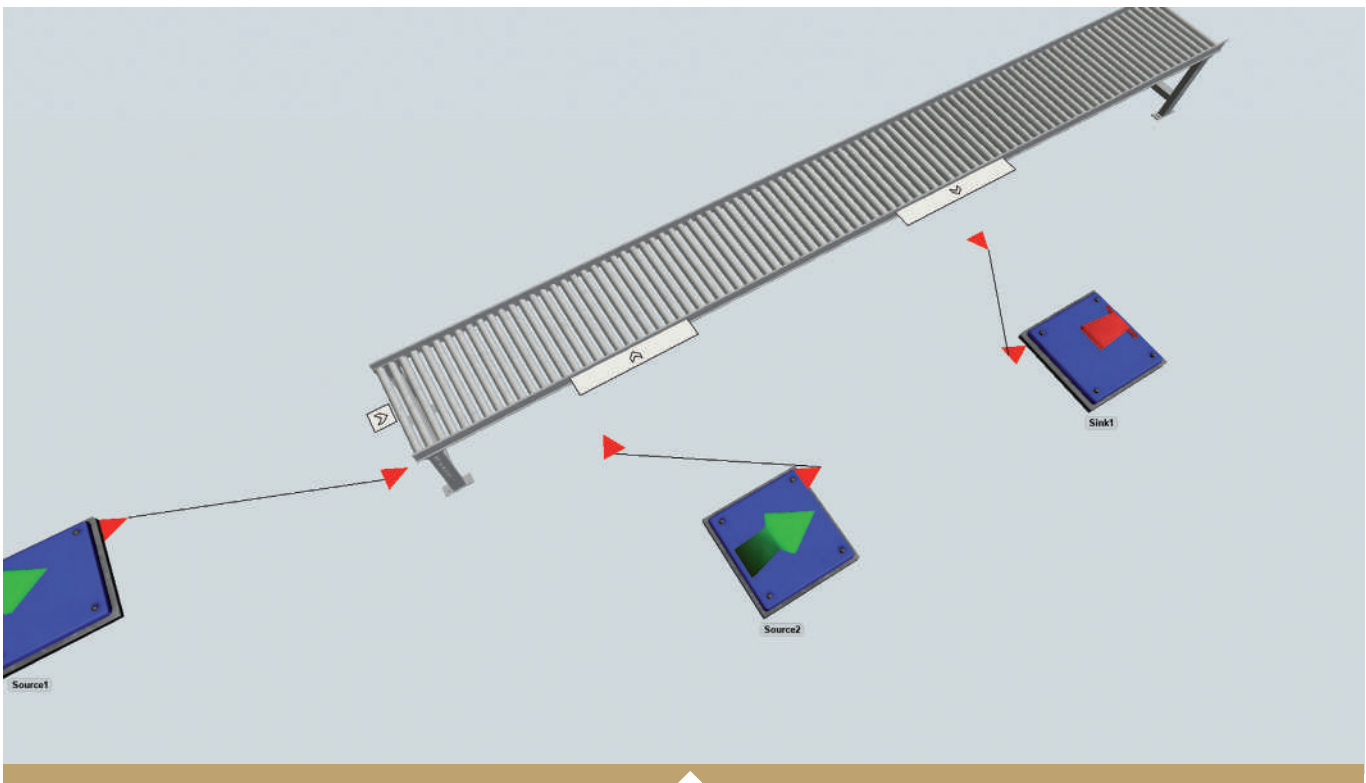

Fig. 10. The updated look of Entry and Exit Transfers.

Digital twin of an innovative process line at Valmont Poland

PIOTR SENDER

chief computer simulation engineer
at Valmont Polska LLC



Valmont has been manufacturing lighting and signal poles, telecommunications towers, power poles, steel structures for infrastructure and agriculture for decades. Recently, companies in the manufacturing indus-

try have been actively implementing automated workstations, also known as a "boxer". This opened up the prospect of flexible management of the workstation and was expected to improve the economic indicators of the production line.

As the maxim goes: don't bring an opinion to a data fight - the numbers speak for themselves

try have been actively implementing automated workstations. Thus, they are striving for reducing labor costs, shortening production time, and reducing the number of defects by means of manufacturing automation.

Valmont, too, is focused on increasing manufacturing efficiency while reducing production costs. Therefore, the company's management decided to implement an automated straightening station for lamp posts.

Of course, any industry must take into account a number of nuances to the production process. In our case, when straightening lamp posts using the traditional method, the human factor is considerable. Accuracy and straightening time are completely dependent on the skills, competence and experience of the specific operator. Thus, we decided to implement in the company an automated straightening workstation to eliminate the need for a worker to have perfect skills

We established a goal - to significantly increase the number of straightened lamp posts at the station while increasing their quality.

The means of achieving it was implementing automatic control of the straightness of the pole.

We decided to verify various options for the possible layouts of the production line using computer simulation before committing to the construction of the automated workstation. This way, we wanted to find the most favorable arrangement.

We conducted a market survey of computer software for production simulation and optimization. After reviewing various options, analyzing the issues with their delivery and the requirements for the deployment of the technical and system infrastructure, we decided to purchase FlexSim.

Significant arguments in favor of FlexSim are its intuitiveness and the fact that it combines advanced statistical analysis with 3D visualization. In addition, we were impressed by the ability to

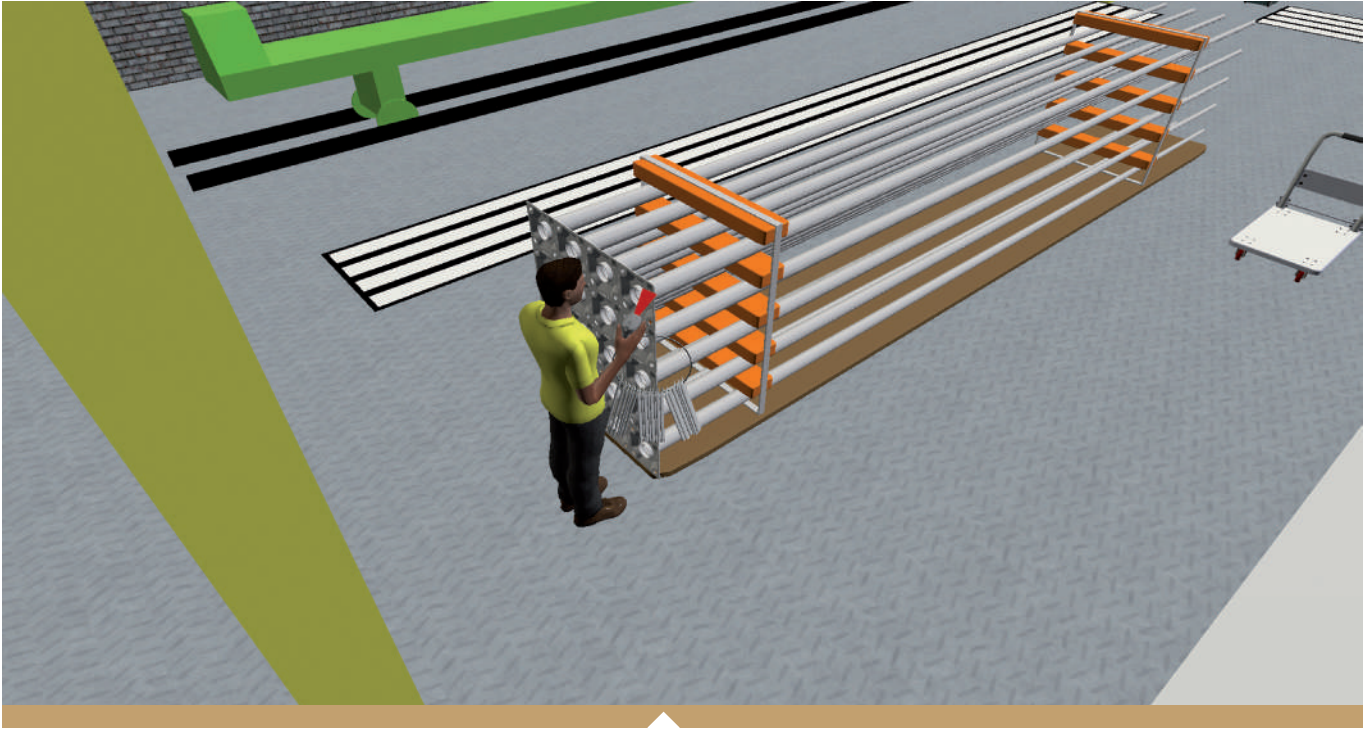

Fig. 1. Example frames from the advanced simulation: scanning with a QR code reader.

verify the machine and worker resources needed to operate the production line. Depending on the parameters of machine operation (linear speed affects, among other things, the displacement time of the workpiece flowing through the workstation), we received different results. This allowed us to predict the achievable operating parameters for the

machines that we plan to introduce in the production line. In addition, we were able to verify operator workload and the utilization of machines, conveyors, forklifts, overhead cranes and other resources.

At the beginning of the simulation work, we created a digital twin of the workstations operating

conventionally. Then a series of numerical simulations was generated to predict multiple scenarios for various options of production line layout. These measures were taken to enable the creation of an advanced simulation model for the newly designed process line.

Eventually, a final report was generated as a result

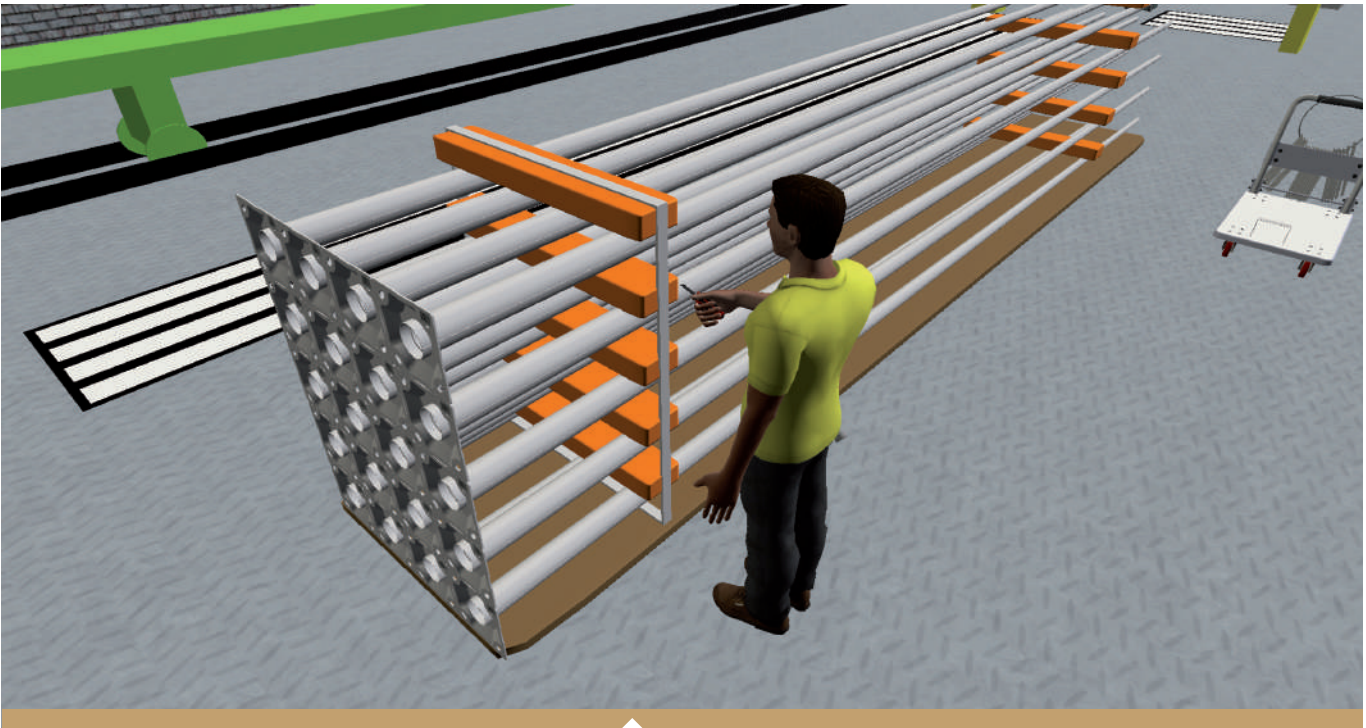

Fig. 2. Example frame: cutting the tape.

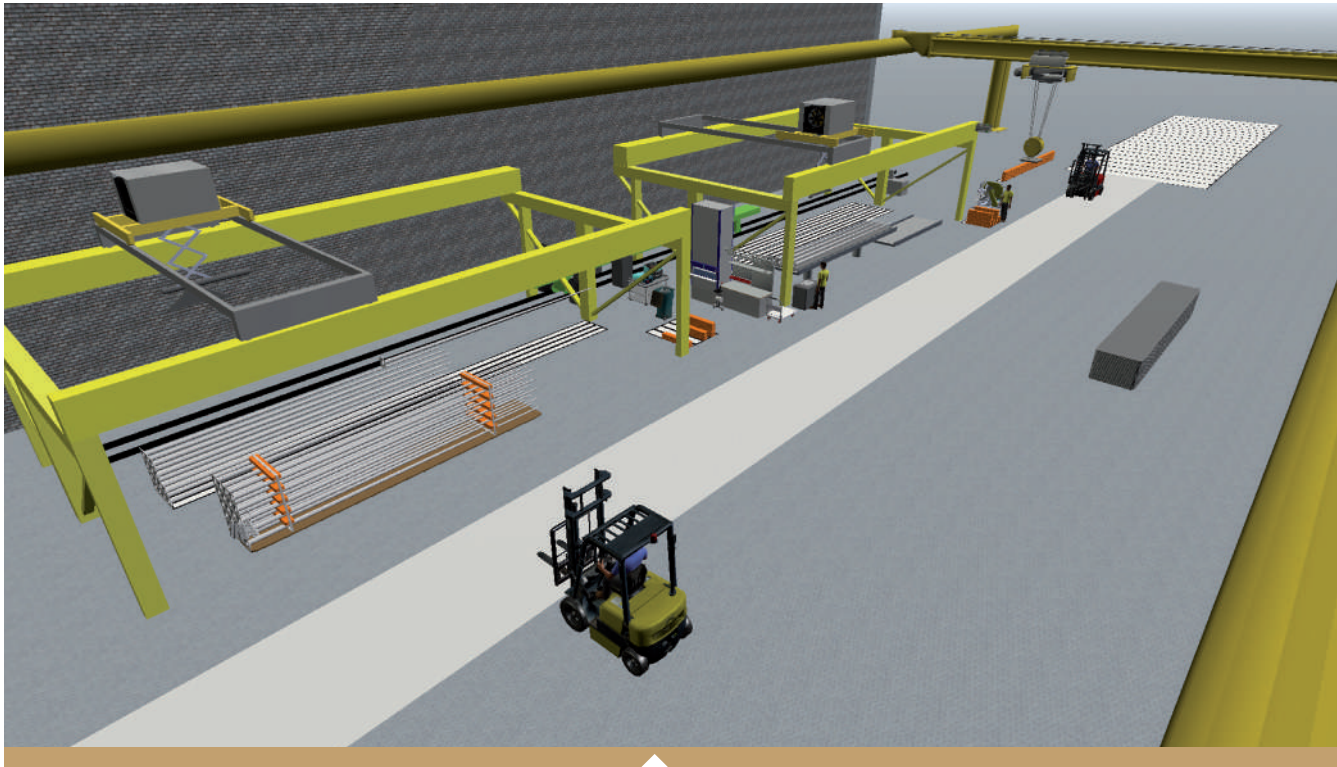

Fig. 3. Example frame: Movement of the operator within the workstation according to a defined path.

of an advanced statistical analysis that indicated the optimal solution. The numerical simulation not only determined the recommended line layout, but also visualized its operation, and that greatly facilitated making major decisions related to the design of the new process line. It should be noted that FlexSim enables visualization of detailed steps of operations, such as pulling out the knife, ejecting the knife, cutting the tape, picking up the cut tape, and tossing the tape into a container. Example frames from the simulation are shown in Fig. 1, 2, 3.

A very important feature in FlexSim is the Process-Flow module, in which practically all activities occurring during production (e.g. elementary movements of the operator or a machine tool) can be defined, taking into account the various criteria for simulation execution (e.g. simulation duration, part movement speed). The figure shows the new Valmont process line in one of the tested layouts. The production line simulator has been prepared in a way that makes it possible to carry out numerical simulations of the workflow for various

sets of data entered into the production schedule, which at Valmont Poland has contributed to the implementation of a modern system for the enterprise resource planning process. Purchasing FlexSim and putting the results of the simulation work into practice resulted in a new automated production station, and that was a wise investment decision. This innovative venture has become the groundwork for the further development of the entire company.





Study of the effect of buffer capacity increase on filling line throughput

DAWID DĄBAL

vice president, FlexSim program director
at InterMarium LLC

This case study shows that simulation using FlexSim is an excellent tool for analyzing lines with high production volumes and high variability. A cosmetics manufacturing company was looking for low-cost improvements to its automated filling lines. The biggest problem was the high variability

1. line layout,
2. process-specific information (line speed, conveyor speed, product spacing, etc.),
3. historical downtime information for each station,
4. buffer capacities between stations.

How to remedy the difficulty of analyzing a high volume production line with high variability?

caused by machine downtime, which made it very difficult to perform accurate and detailed flow analysis with tools used so far such as MS Excel. The main objective of the simulation using FlexSim was to determine the optimal buffer size for the filling line. Because the line had been in operation for about a year, we were able to collect an

We used the ExpertFit tool to fit statistical distributions to historical data. We used these distributions in the MTBF/MTTR module at individual stations to accurately model downtime and the disruption it causes to material flow on the line. Downtime can cause machine utilization levels to drop due to lack of material (downtime at an

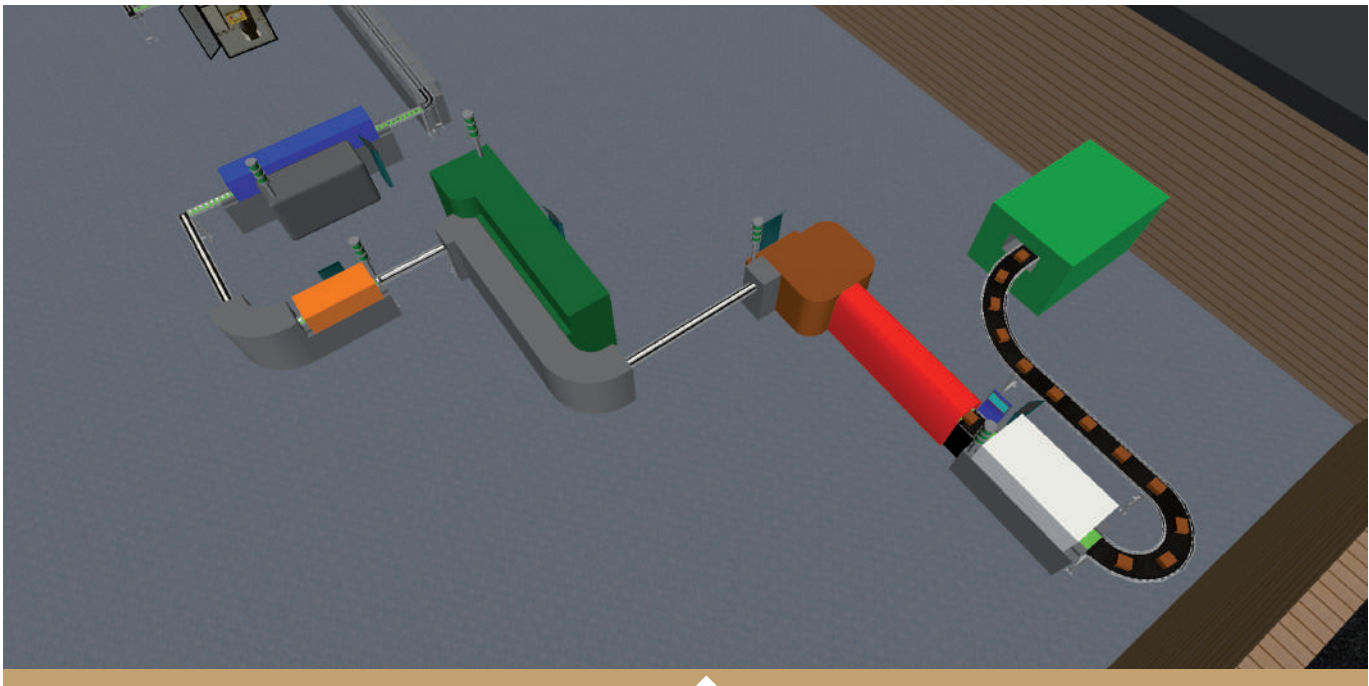

Fig. 1 View of a portion of the line in FlexSim.

adequate amount of data on micro stops (in this case, less than 60 seconds) and longer periods of downtime for each machine on the line. Based on the data received in the first step, we created a model of the current state of the line. The data used were:

upstream station) or due to station blockage (inability to unload material - downtime at a downstream station). The next step was to verify whether the simulation results matched the actual performance of the line. After a successful test, we proceeded to

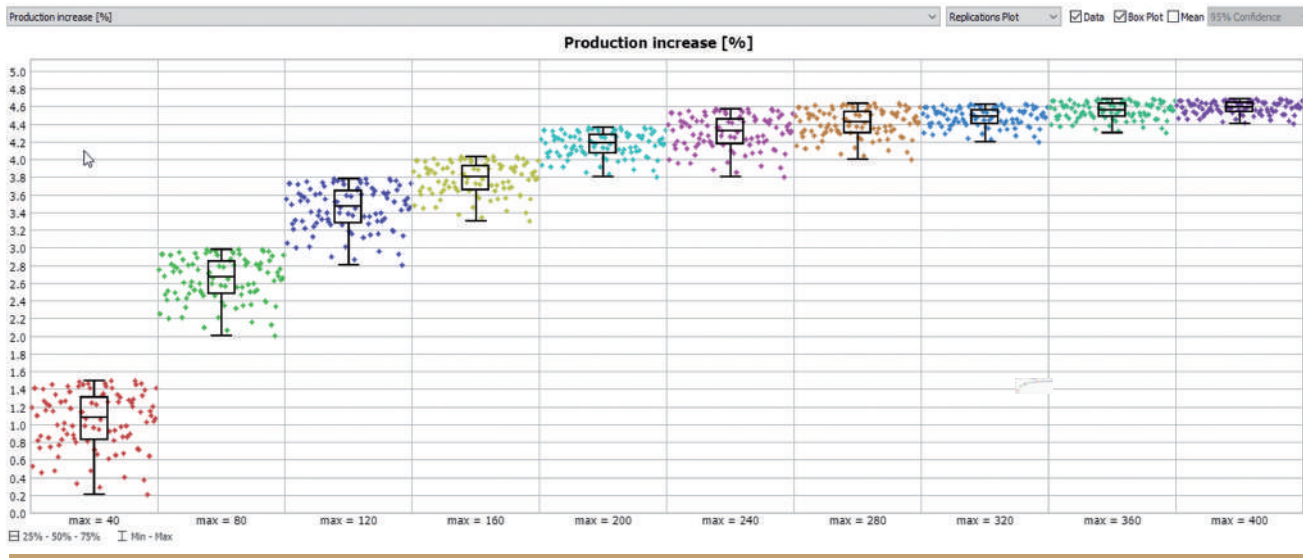

Fig. 2: Results of the analysis performed in the Experimenter tool.

experiment with various buffer sizes between the filling and labeling stations.

The nature of this problem (i.e., the high variability of machine downtime and the need to analyze the buffer content over time and its impact on throughput) makes simulation an excellent tool for its analysis. The FlexSim Experimenter tool allows users to run a sufficient number of simulation replications to achieve a satisfactory level of confidence in checking and comparing all the tested scenarios. In our case, they will involve different

average hourly yield from several replications of one week's production.

The chart below shows the results of the scenario analysis conducted using the FlexSim Experimenter. The Y-axis shows the increase in average hourly yield as a percentage of the current average yield on the line, while the X-axis shows the analyzed scenarios - in this case, the different proposed sizes of the buffer (multiples of 40).

Any increase in the buffer size has a positive effect on throughput, but the relationship is not linear. It

reaches diminishing returns. We can also see that the larger the buffer, the narrower the mean confidence interval of the average production, which translates to greater predictability of daily production volumes.

After analyzing the findings, a buffer of 200 units was decided. This will result in a production volume increase of about 4% provided a relatively small expenditure with short implementation time.

In summary, it took about 2 weeks to build the

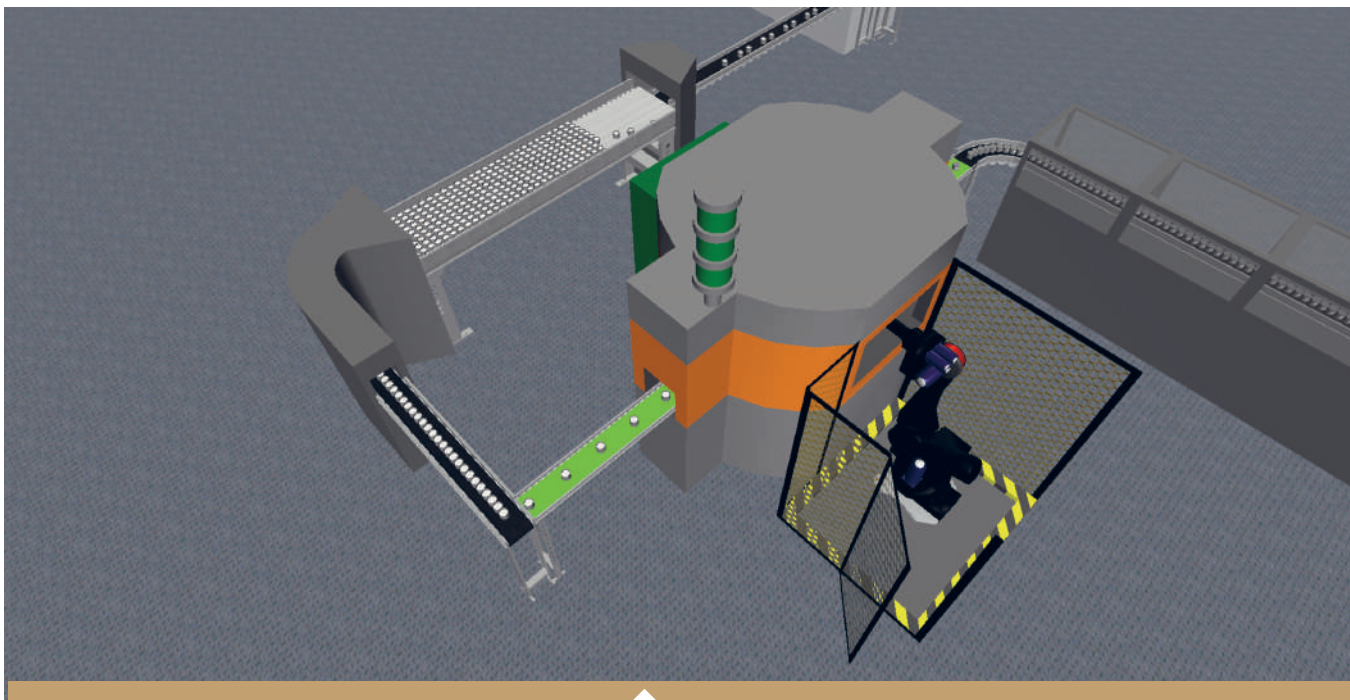

Fig. 3. Increased buffer upstream of the labeler

buffer sizes - due to the line layout, the buffer can be located in only one place, but its maximum content will be determined by its width.

The key performance indicator for the project was the hourly yield of the filling line, calculated as the

was impossible to achieve a productivity increase of more than 5% in any of the scenarios. If we add a buffer for 240 units, we gain about 4.3%, while for a buffer for 400 units we gain 4.6%. We can see that further increases in buffer size quickly

simulation model for this case, and it resulted in a thorough analysis of the effects of adding a buffer on the line and selecting the optimal solution in terms of the cost-benefit ratio (investment - efficiency gains).

Optimization of production batch size

DAWID DĄBAL

vice president, FlexSim program director
at InterMarium LLC

Simulation is used not only during greenfield projects or new investments. FlexSim, due to its ease of use, can also be successfully employed to solve current issues on production lines or in logistics systems. The lead time for simulation models does not have to be weeks. They can be built in less than a few hours provided you don't care about visualization and can isolate the problem.

In this article, I will describe a model that was created during a simulation workshop we conducted. The purpose of this workshop was convincing the continuous improvement department that simu-

workstations was also taken into account.

The data fed into the model were: processing and changeover times for the products, line layout and production sequence. The model operated under the assumption of deterministic processing times. Once all the data was collected, putting the simulation together took less than 20 minutes.

The chosen KPIs were the line throughput per shift (number of finished pieces / 7.5 hours) and the ratio of insulation station productive time to shift duration expressed as a percentage.

Using the Experimenter tool, a series of experi-

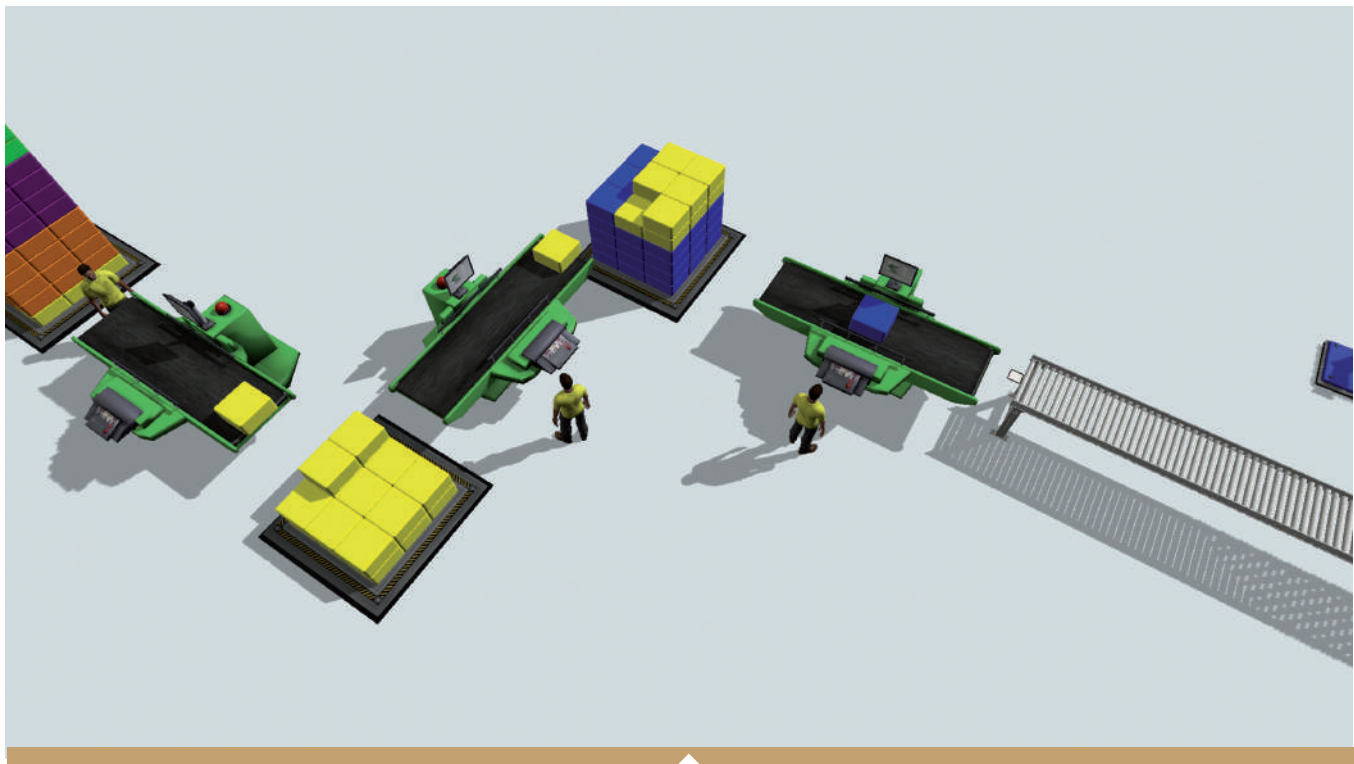

Fig. 1: View of a portion of the line in FlexSim.

lation would be able to effectively support them in their day-to-day tasks.

The problem lay in determining the optimal batch size for one of the welding lines. The process comprises 3 stations: part preparation, welding and insulation. Between batches, the welding and insulating stations need to be set up. Due to the specifics of production, welding is a much slower process than insulation, but with relatively short changeover times. Insulation, on the other hand, is faster than welding, but it has a much longer changeover time. The size of buffers between the

ments was conducted for different batch sizes from 30 to 200 pieces in increments of 5. A total of 35 scenarios was tested.

Analyzing the results, it can be noted that for lot sizes above 120 pieces, productivity no longer increases significantly and remains in the range of 1600-1650 pieces per shift. What may be puzzling are the fluctuations in productivity for batch sizes ranging between 125-200 pieces. These are caused by variation in the number of changeovers at the insulation station and their timing. Depending on whether a changeover falls just before or just after

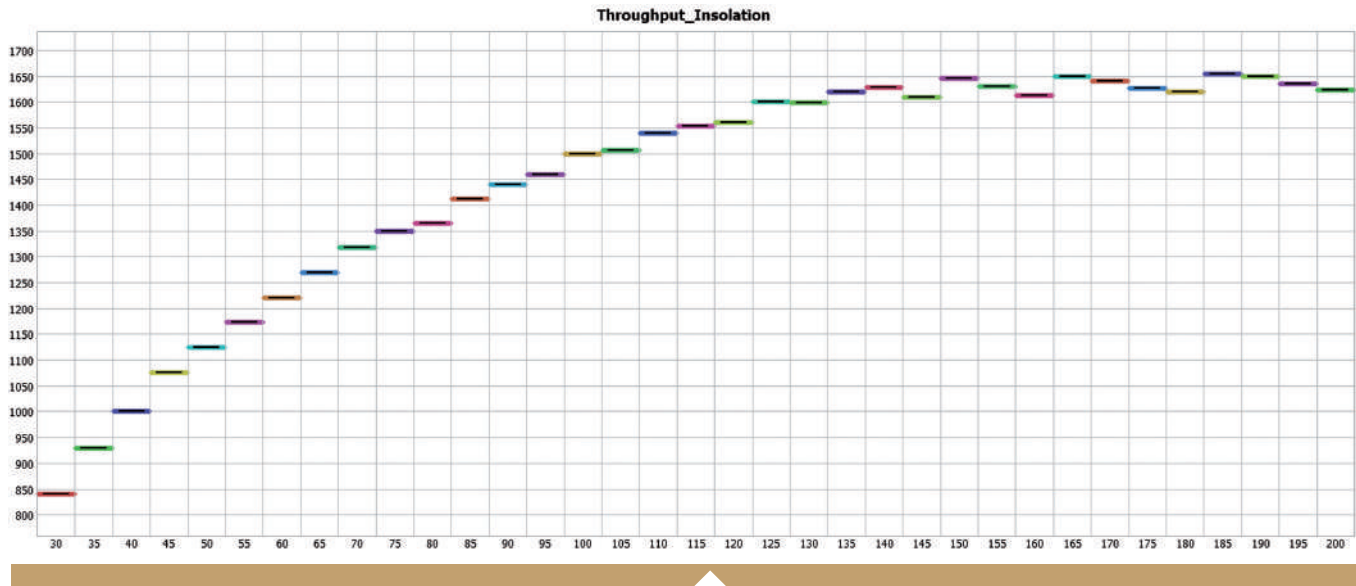

Fig. 2. Results of simulation experiments (X-axis: batch size, Y-axis: pieces/shift)

the end of a shift, productivity can seemingly decrease or increase, respectively. To address this issue, a decision was made to change the performance measure, and so productivity was evaluated for continuous production over a period of 100 shifts.

shows how important it is to carefully determine the appropriate KPIs.

Putting the model together, conducting experiments, discussions - the entire workshop lasted about 2 hours. This is an excellent example that FlexSim can also be successfully used for small,

Find out how long it takes to create a model to determine the optimal batch size for a production line.

After repeating the experiment, we observed that productivity no longer increases significantly for batches larger than 130 pieces. This example

quick projects to support managers in solving current problems.

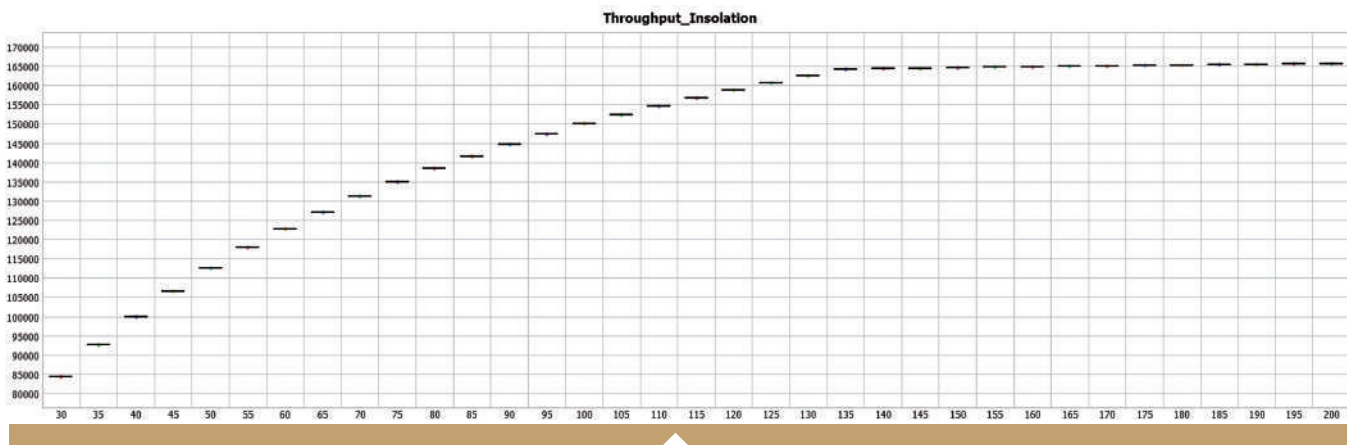

Fig. 3. Results for the experiment after extending the scenario simulation period (X-axis: batch size, Y-axis: pieces/100 production shifts)



Creating digital twin in the internal logistics industry

WOJCIECH SKWIRA

director of the internal logistics section
at MPL TECHMA LLC

MPL TECHMA LLC was established in 2003. We develop completely new solutions, and create machines that increase production capacity. The most important branches of our development are high storage warehouses and short distance transport. As we anticipate the needs of the market for storage, management and transportation of goods, we develop our own solutions. We supply automatic storage systems based on ASRS, transport shuttles as well as other solutions tailored to the application. The storage and transfer of goods can be done on pallets and other carriers. We prepare dedicated transport systems that work with the warehouse area. The offered solutions are fully automated and integrated with the appropriate IT system.

We have been using FlexSim for many years to

simulation scenarios. And that in turn translates into reduced lead time and the choice of an optimal solution. In this article, using a concrete example, we will show what valuable tool simulation scenarios are when working out the optimal solution.

Problem Statement

Before the start of our cooperation, the storage and product sorting system of the client was based on wire containers arranged in a 20m square. The operators needed to manually roll each product into one of these containers. This was an inefficient system that required human labor under harsh conditions such as elevated temperature or product weight of up to 120kg and therefore was error prone.

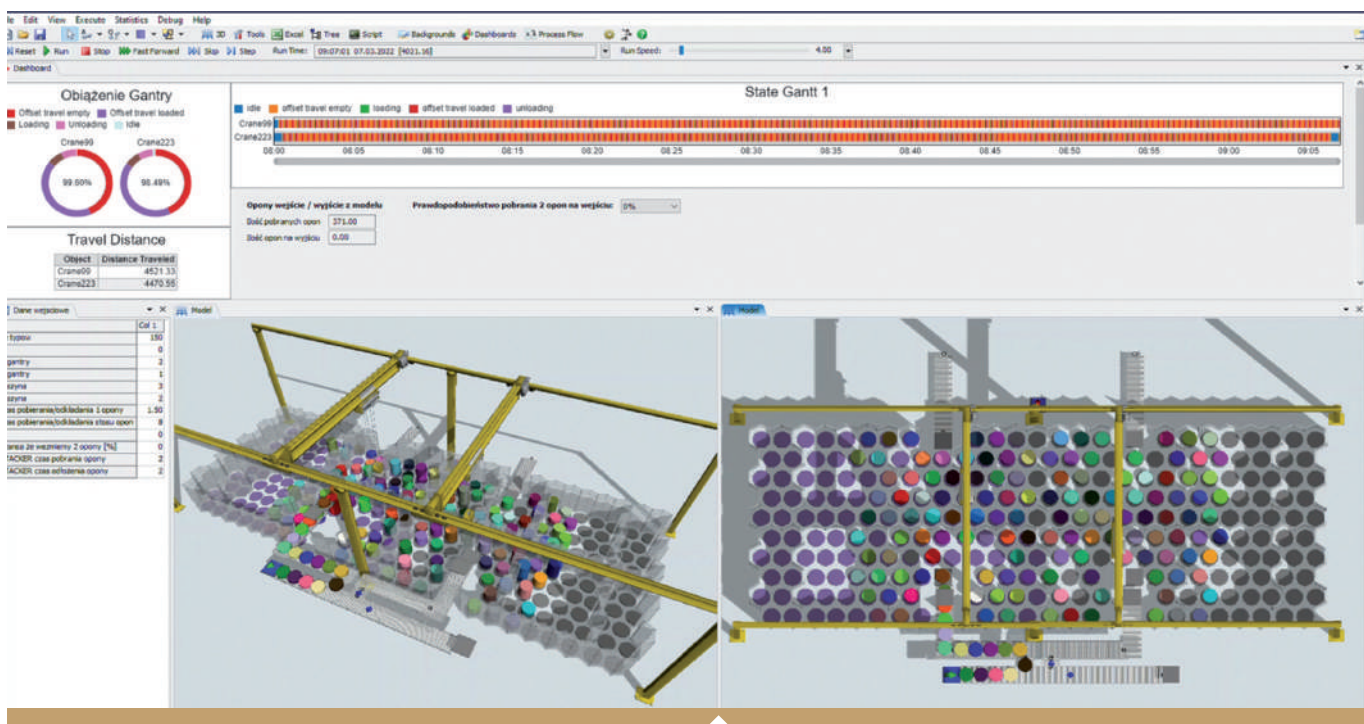

Fig. 1. System of two independent gantries in FlexSim

create digital twins in the area of internal logistics and beyond. We create such simulations as early as the quoting phase. Thanks to this, our customers are able to see the process and related operations even before the project is implemented. This allows us to detect bottlenecks and learn about the performance of the system under various

Client's requirements

The main challenges stated by the client were :

- optimization of the process of transporting, storing and sorting more than 250 product types,
- integration of multiple transport zones located on different levels,

- incorporation of the new system into the existing infrastructure of the warehouse,
- elimination of manual processes,
- increase in the warehouse capacity through multi-level storage of product while ensuring correct sorting by product type during stacking,
- increased efficiency of warehouse operations,
- redundancy of the system in case some of its parts fail.

Solutions

The following solutions were under consideration:

- ASRS,
- two-axis gantry,
- three-axis gantry.

- to one of the three analyzed pick-up points, efficiency of the manipulators - under the assumption of maximum operating parameters,
- number of product types flowing in from production at any given time,
- repeatability - we assumed that there is a high probability of taking two products at once and placing them in different locations in the system. We determined this probability in percentages reflecting the frequency at which the system is expected to take a double package.

The results yielded by the selected parameters can be compared on a bar chart.

Based on such a report, together with the customer, we could decide on the final design of the system.

When building a simulation, it is important to remember that the quality of the outcomes depends greatly on the quality of the fed data. The more realistic the input data is, the more the achieved results resemble the real conditions. Otherwise, the virtual model will have unacceptable inaccuracies, which in turn translate into an incorrect analysis of the problem. Consequently, this can lead to unnecessary discussions about a problem that doesn't really exist, or worse, we may fail to detect an actual serious problem or bottleneck in the process.

Conclusion

Our competitive advantages are flexibility, and individual, clear, pictorial and thus understandable preparation of each project. These result in a system tailored to individual customer needs. We are

When creating transportation systems for the warehousing we can use simulation to visualize the process and related operations even before the project is implemented. This allows us to detect bottlenecks, learn about the performance of the system under various simulation scenarios, and that in turn translates into reduced lead time and the choice of an optimal solution

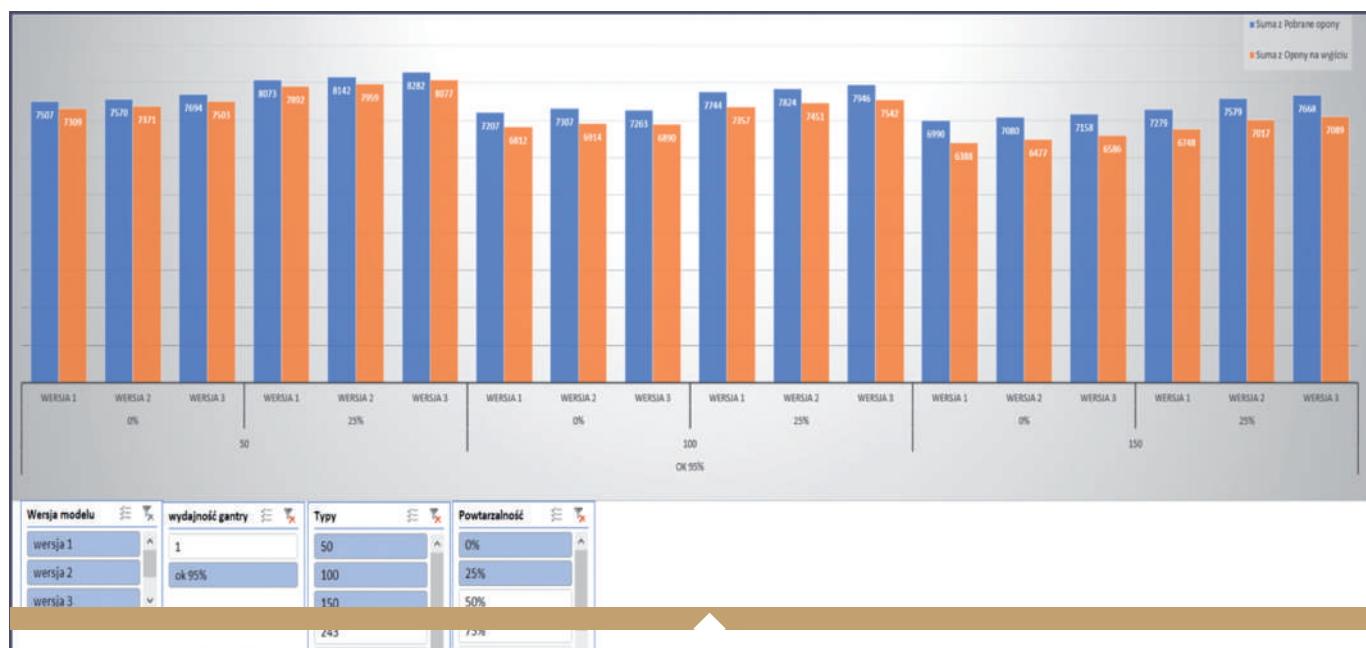

Fig. 2. Excel report based on an example parameter set

Solution Choice

The criterion for the decision was to meet as many of the client's requirements as possible. A system comprising two independent three-axis gantries was chosen, each of which handles half of the warehouse. In an emergency, each gantry can handle the entire warehouse. Based on these assumptions, a simulation was made, which is shown in Fig.1.

The results were communicated to the client in the form of an Excel spreadsheet. The client was free to change the simulation parameters, such as:

- model version - this parameter corresponds

Advantages

- reduction to 0 of the number of employees tasked with sorting these products,
- reduction by 99% of errors related to incorrect sorting of product types,
- redundancy of the system,
- optimal use of available warehouse space,
- reduction of costs,
- increased efficiency and safety of warehouse operations,
- possibility of further expansion of the system in the future.

able to offer the customer not only the warehousing, but also the entire transport and material handling facilities upstream and downstream of the warehouse. We take responsibility for the entire investment as a general contractor, from the analysis of needs and development of concepts, through design, to commissioning and implementation.

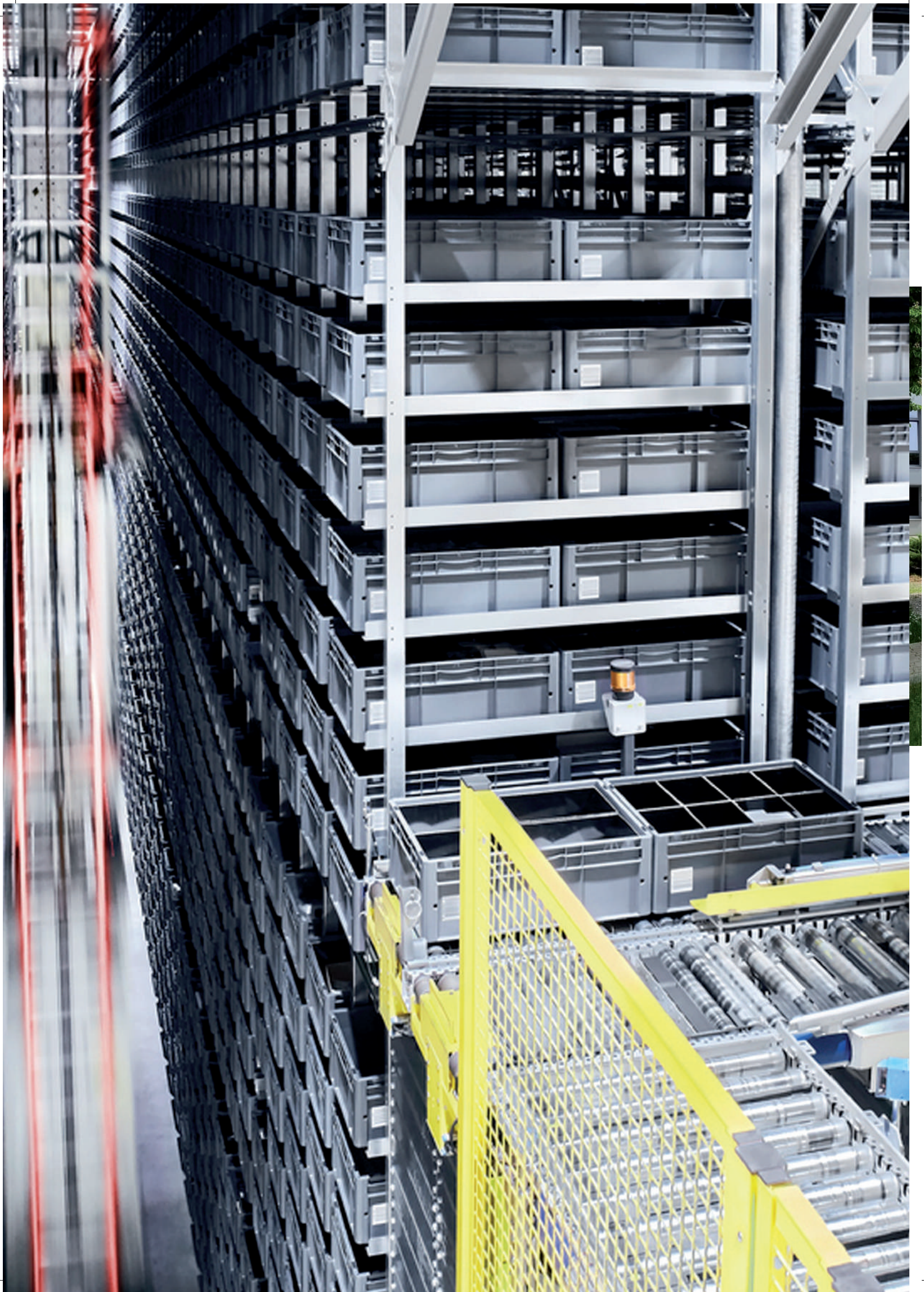

An interview with professor Krzysztof Nowosielski



LEADER

An interview with Krzysztof Nowosielski, PhD, originator and manager of Business Process Simulation Center (BPSC) at Wrocław University of Economics and Business (WUEB).

Let's start with some basic facts about you.

What is the scope of your career interest?

I am a researcher and lecturer at Wrocław University of Economics and Business. I work in the Department of Process Management and, most recently, I have been the manager of Business Process Simulation Center. I should point out that this facility is the outcome of project PORTAL – Integrated Programme for WUEB Development, and that this project is co-financed by the European Union. My early beginning at the WUEB is related to management control systems, that is budgeting, cost accounting, management reporting and that sort of thing, but for several years business process management has been my main area of interest.

And what is BPSC?

First of all, it is an original, ultra-modern research and didactics facility, designed for interactive

simulation of business processes. It was incorporated in the WUEB infrastructure several months ago. It offers 20 high-performance PC stations, powered by FlexSim, including 6 independent VR workstations, which allow the users to visualize and interact with the designed processes in a computer-generated environment with objects that appear to be real. Currently, the users of BPSC have at their disposal dozens of virtual decision-making games centered around logistics, production and service process models, all developed in FlexSim. These games are used as teaching aids during classes, allowing users to get acquainted with 3D model of the process and its flow. We copy real processes and managerial problems from business and implement them in FlexSim. Thus, students can play the role of managers, decision makers, realistically affecting the process performance without leaving the WUEB campus. Our first experiences are very encouraging.

Could you explain a little more the topic of ultra-modernity of BPSC?

This facility goes far beyond the solutions applied at Polish, or even European universities. It was specially designed to allow comfortable work with process models, both when it comes to process design and its visual simulation. In its own way, it meets the requirements of the Industry 4.0 concept, but applied in an academic environment. In addition to the aforementioned virtual decision-making games, which in themselves are a novel and original use of FlexSim, BPSC is a unique facility. An undeniable advantage of this object is its modular construction, which allows it to be upgraded relatively easily. Now it is a one story facility, but we can attach several more modules to it, each with a different functionality. Moreover, this object sets new standards in terms of complexity of intelligent solutions for building management systems (BMS) and access control, making it extremely user friendly, but also cost-effective. Thanks to the implemented "audio-video cloud" integrated with BMS, or virtual reception, the users can have access to a unique, fully automated, highly efficient and economic platform. The use of a heat pump makes it ecological too, which is very important nowadays, isn't it?

Where did the idea for this kind of a facility come from?

The idea came to me about 10 years ago. It was just after reading an article presenting the results of an experiment comparing push and pull production systems. What inspired me most was one shortcoming of the research method. The experiment required 2 groups of students to execute a certain scope of manual activities, separately for each production system. I thought it would be nice to have some kind of a way at our university to visualize and flexibly affect such processes without the need to have someone carry them out. Unfortunately, at that very moment, the idea could not have been implemented and I put it aside for the time being. In 2017 the idea was reactivated. The technology was ready, the money was accessible and the authorities of WUEB gave a green light to start the idea of BPSC.

What was the biggest challenge in this project?

Because the facility is unique and original in every way, it was not possible to use ready-made solutions or patterns to benchmark against. It was impossible to find any similar examples and see what is and what is not worth doing. Obviously, both hardware and software solutions had existed on the market before this project started. What I mean here as an example, is FlexSim, or the system for transmission and management of the AV signal. However, figuring out how to use, combine and configure these elements into a single, coherent and logical system was probably the biggest challenge I faced. I was very fortunate to come across specialists who understood my ideas and expectations and engaged in 100% in this project.

What part did people play in this undoubted success?



Without doubt, people play enormous role in this project. Both my team, made up of WUEB employees and external co-operators, have influenced the BPSC creation and made it possible so that its shape and functionality are like originally planned. I didn't have to give up any of my ideas and I didn't have to simplify any of my assumptions. I was supported by specialists in every important issue. When you have an idea in which you believe very strongly, but you don't know the operating solutions or have an unclear vision, you need professionals around you to help you understand and explore the topic and find the right way.

How suitable is FlexSim for decision-making games, and what dictates how successful a decision-making game is going to be?

In my opinion, FlexSim is a very good environment for decision-making games. It has several important attributes that give it an advantage over other solutions. First, it provides the ability to design a process using 3D graphics objects, both in terms of active and passive process participants, i.e. the resources used in the process and so-called flow items. This is a very important feature, especially when we consider the expectations of students of the Z-generation regarding the graphical presentation of the contents of the class. Visualizing the process models in 3D, as well as in VR, helps us, academic teachers, reach the audience in a better way. The next thing is FlexSim's high flexibility, which allows us to design and visualize not only typical production or service processes, but also to show, for example, the flow of documents, which is of great importance to academic teachers leading such management courses as management control, cost or management accounting. The huge advantage is that FlexSim features experimenting and optimization tools, and that makes it possible to use decision-making games in the research area as well. With FlexSim's open development environment, we can add custom solutions to our models. Decision-making games, which are available on the market, do not allow us to make changes or improve models without the

manufacturer's participation. FlexSim is primarily a simulation environment that allows us to implement any concept of process model or managerial decision problem. We prefer to invest money in our academic staff so that we can create and improve process models by ourselves.

What would you advise someone who wants to carry out a similar venture? How to go about it?

As I said before, human factor is the key to success in any project, especially when it has innovative outcomes. This must be borne in mind, because either alone or with a poorly chosen team, we will not go far, or waste our energy in vain doing so. We also need to remember that the idea itself is more important than financial or other material resources. If a valuable idea – that is, one that responds to certain needs, even those that are just beginning to outline – is internally consistent and logical, it will quickly reach the audience, inspire people to act, and engage them in the project. When you start your project thinking about its financial performance, or the return on investment, you may easily lose motivation. I think the idea is the most crucial. The financial, organizational or technical matters are of secondary importance.

Can we say the project has been already finalized?

Certainly not! Today I can't reveal the details of our new idea, but I can say that we are working hard to incorporate FlexSim functionality and our decision-making models into some research projects. But now we are still in the conceptual phase of this project, with more questions than answers. Thank you for the interview. I wish you every success with all your projects.

The interview was conducted by
Natalia Witkowska-Cempel
 the editor of *Simulation Manager*



FlexSim is first and foremost about people

WITOLD ALEKSANDER CEMPEL, PhD

the president of InterMarium LLC

COLUMN

FlexSim is an outstanding, state-of-the-art software for modeling, simulation and analysis of manufacturing and logistics processes. But what would this software be without a competent user? Well, the utility of software depends on the people. In order to achieve spectacular results with a powerful tool such as FlexSim, it is first necessary to take care of talented, insightful staff. Then to take care of systematic education in FlexSim in various ways. Knowledge can be gained by learning from the manual¹, the books "Applied Simulation"², and "Primer"³, our latest manual⁴, webinars⁵, through the e-learning platform⁶, on our InterMarium YouTube⁷ channel and the official FlexSim channel⁸, and on the user forum⁹. However, by far, the fastest and most effective way to learn FlexSim is through dedicated training courses and workshops¹⁰. What else is needed besides knowledge to achieve

fascinating results in modeling? Applying the acquired knowledge in practice. This is how skills and abilities are developed. The more we use the tool, the more versed in using it we become. The more we learn and master the program, the better in modeling we will be and the faster we will deliver fascinating results.

Is working alone in FlexSim the most effective? No. As mentioned in the title - FlexSim is first and foremost about people. Only the exchange of ideas, knowledge and experience among simulation enthusiasts gives the opportunity to jump to a higher gear in simulation modeling. That's why we recommend setting up simulation teams inside the organization, placed high up in the organizational structure with a mentor and sponsor at the board level (C-level). In such teams, mutual help and inspiration can take place on an ongoing basis, and

support “from the top” provides the opportunity to quickly put modeling results into practice, thus triggering a positive reinforcement loop. Is the knowledge, team and regular use of FlexSim enough to produce remarkable results? In many cases it is, but they are much easier to achieve with the support of knowledge and inspiration from outside the organization. To this end, a community

of FlexSim modeling enthusiasts has been established. You can exchange ideas, knowledge and experience at conferences and symposiums that we regularly organize. You can meet the members of the FlexSim community during one of the events announced on our website¹. In between conferences, we also organize thematic webinars, for which you can sign up via a form on the site. If

you wish to meet earlier, you can make an appointment with us through the contact form. Who makes up the FlexSim community? It is the elite of the industry, academia and public administration. Isn't presence in such a respectable group a value in itself?

¹<https://docs.flexsim.com/en/22.1/Introduction/Welcome/Welcome.html>

²<https://en.flexsim.pl/book-and-services/textbook-applied-simulation/>

³Available on request at: <https://en.flexsim.pl/contact/>

⁴As above

⁵<https://en.flexsim.pl/webinar>

⁶<https://flexsim.edu.pl/?lang=en>

⁷https://www.youtube.com/channel/UC1yhrizfuNoh3_yo-uGmog9

⁸<https://www.youtube.com/c/FlexSim>

⁹<https://answers.flexsim.com/index.html>

¹⁰<https://en.flexsim.pl/book-and-services/flexsim-opened-and-closed-training-courses/>



Recent events

Recent months have been a busy time for InterMarium and the FlexSim community. Many interesting events and exciting projects are behind us. See how we are changing the world for the better!

Recent months have been a busy time for InterMarium and the FlexSim community. Many interesting events and exciting projects are behind us. See how we are changing the world for the better!

Optimization and Simulation Engineer of WSB University

A specialization first of its kind in Europe called Optimization and Simulation Engineer was created at the Logistics Department of WSB University in Dąbrowa Górnicza. We successfully implemented a special university program tailor-made for this educational unit. We equipped the WSB University laboratories with a full suite of specialized simulation modeling software from FlexSim Software Products (FlexSim GP, FlexSim HC), Moffatt & Nichol (FlexTerm), as well as Talmis (FloWorks) and Opttek (OptQuest). Thanks to these assets, WSB University, through its partnership with us, can train individuals in the new and increasingly popular profession of simulation engineer. The work in this novel profession is creative, interesting, well-paid, can be independent or team-based, and, last but not least, delivers tangible results for the entire industrial organization. Simulation engineer is a new profession that is part of the global trend of Industry 4.0 transformation, so it has a good outlook.

Production Engineering and Management at the Silesian University of Technology



Photo 1. Professor Arkadiusz Mężyk, Rector of the Silesian University of Technology in Gliwice, and Witold Aleksander Cempel, president of InterMarium LLC.

FlexSim InterMarium has been cooperating for years with Silesian University of Technology, one of the best technical universities in Poland. The Rector of the Silesian University of Technology in Gliwice, Professor Arkadiusz Mężyk, PhD, and the President of InterMarium, Witold Aleksander Cempel, PhD, signed an agreement in March 2021 to patronize a new course of study, Production Engineering and Management, at the Faculty of Mechanical Engineering. FlexSim and simulation modeling will be an important subject there for the undergraduate and graduate degrees.

Opening ceremony of the hub4industry showroom



Photo 2. The speech of Dawid Dąbał, vice president, FlexSim program director at InterMarium LLC.

During the opening ceremony of the hub4industry showroom in April 2021 in Kraków, Dawid Dąbał, vice president, FlexSim program director at InterMarium LLC, gave an excellent presentation titled "Process Simulation on the Way to Digital Twin". During this talk he presented simulation as one of the pillars of Industry 4.0 and explained its significance when creating a digital twin. The event was held online, and the attendees had the opportunity to ask questions.

FlexSim InterMarium at INTARG

From June 15-16 2021, we participated in the "14th International Invention and Innovation Show INTARG" organized by the Eurobusiness-Haller foundation. The event was held entirely online.

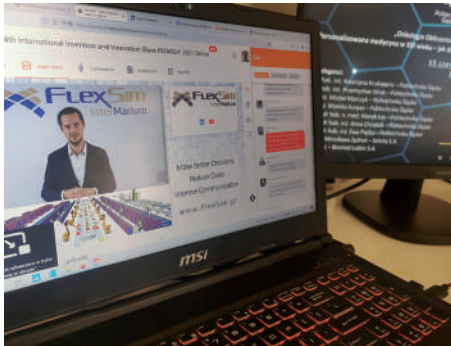

Photo 3. Screenshot of the presentation given by Filip Polit, national sales director at InterMarium LLC.

InterMarium at Logistic and Warehouse Trends conference



Photo 4. Patryk Żuchowicz and one of the participants at the conference.

In mid-September 2021, we visited Łódź to present the capabilities of FlexSim at the Logistic and Warehouse Trends conference. InterMarium was represented by Patryk Żuchowicz, senior simulation engineer, and Filip Polit, national sales director.

The opening of the Business Process Simulation Center at Wrocław University of Economics and Business

On October 18, 2021, the Business Process



Photo 5. The computer lab of the Business Process Simulation Center.

Simulation Center was officially opened at the Wrocław University of Economics and Business. And although there are already many industrial process simulation laboratories based on FlexSim in Poland, the Wrocław center is unique. It is exceptional in the technologies and materials used, and the vision of the entire project, which is authored by Krzysztof Nowosielski, PhD. What pleases us the most is that the core of the entire project and the main sense of its functioning are both the FlexSim simulation software provided by InterMarium, and the dozens of virtual decision games we have designed. This is where simulation in academia happens at the highest level!

The Smart Production Lab Network at Kielce University of Technology



Photo 6. The participants of the seminar that initiated the Smart Production Lab Network.

In October 2021 a seminar was held at the Faculty of Management and Computer Modeling of Kielce University of Technology that initiated the creation of an international network of universities dedicated to the research and development of cutting edge technology for Industry 4.0. We are proud to announce that FlexSim InterMarium, along with Festo, is a strategic partner of the Smart Production Lab Network. The author of this idea is Sławomir Luścinski PhD, the head of the Intelligent Production Systems Modeling laboratory at the Research and Development Center (CENWIS) at Kielce University of Technology.

Social Council at Silesian University of Technology

In November 2021. Natalia Witkowska - Cempel, Witold Aleksander Cempel, PhD and Filip Polit were appointed as members of the Social Council of the Faculty of Mechanical Engineering of Silesian University of Technology for the term of 2021-2024.

The new headquarter of InterMarium LLC



Photo 7. K1 office building at Aleja Pokoju 1.

At the turn of the year, the InterMarium Company changed its headquarters. We are now located in the K1 office building at Aleja Pokoju 1. It is one of the tallest skyscrapers in Kraków. We have unparalleled views of the city and the surrounding area. We wish our clients and ourselves to be able to rise above everyday worries and limitations.

A series of trainings for the students of the University of Applied Sciences in Nysa



Photo 8. Filip Polit with one of the students during the training at the University of Applied Sciences in Nysa .

At the end of 2021, we gave a series of training courses on creating simulation models in FlexSim for students of the University of Applied Sciences in Nysa. The students first received basic training using our e-learning platform, and then participated in a two-day on-site session with qualified InterMarium instructors. Part of the training also included operating the simulation model in virtual reality, thanks to the VR module integrated into FlexSim.

ElvalHalcor became a FlexSim user

ElvalHalcor, a global leader in aluminium and copper processing industry, became a licensed FlexSim user at the turn of 2021/2022. Elvalhalcor's simulation team visited Kraków twice this year to

receive professional training on how to utilize simulation at Elval, the aluminium rolling division of the company. According to Apostolos Besis, Elval's process optimization manager, simulation is expected to upgrade processes and redesign strategies for optimal performance. Among the tools available in the market, they chose FlexSim since it already proved its usefulness in the past projects done by FlexSim InterMarium. "The quality and level of expertise of the training we received only reinforced our conviction that we had made the right choice," says Athanasios Psarros, product & process development engineer. "And all of this was perfectly matched by the first-class hospitality we experienced from the InterMarium team in Kraków!"

Roadshow 2022



Photo 9. Wojciech Skwira (MPL Techma LLC) during the conference in Gdańsk (June 6, 2022).

In late May and early June 2022, InterMarium held Roadshow - a series of small, local conferences. They took place in Wrocław, Mielec, Gdańsk and Łódź. During these events, we proved to all participants in an accessible way and based on real-life case studies that investment in simulation technology is a hit! The Roadshow formula will certainly continue in 2023.

Partnership agreement with Warsaw University of Technology

Warsaw University of Technology has been using FlexSim at the Faculty of Transport for years. The cooperation in teaching and simulation design in FlexSim resulted in the creation of the Simulation Laboratory several years ago. At the end of May 2022 a partnership agreement between InterMarium and Warsaw University of Technology was signed, in which the parties expressed their willingness to cooperate extensively in the following aspects: examinations and certification of students in the use of FlexSim simulation software, initiation and execution of joint research work, scientific internships, joint participation in national and international research, educational, informational and technical initiatives, structuring of career paths of students and graduates of the Faculty of Transport of Warsaw University of Technology, support for industrial internship programs.

5th International Conference on Design, Simulation, and Manufacturing in Poznań

From June 8 – 10 2022 InterMarium's delegates Krystian Kogut, international sales director and Przemysław Pasich, simulation engineer, have been Keynote Speakers at the 5th International Conference on Design, Simulation, and Manufacturing. The InterMarium delegates presented FlexSim's offer to higher education. In particular, the novel tool for didactics created by the InterMarium team: simulation games. This year's conference, organized by Sumy State University in Ukraine along with partners, had a hybrid form. A number of participants gathered in Poznań University of Technology (the official host), while the others joined online.

Aimtec is reaching for the best tool for dynamic, 3D process simulation - FlexSim

Aimtec, based in Pilsen in the Czech Republic, is a leader in digitizing manufacturing and logistics processes, a highly regarded SAP, ERP, and scheduling tools provider. And now, to support their clients in an even more complex manner, they are reaching for the best tool for dynamic, 3D process simulation - FlexSim! Isn't it natural, that the best wants to work with the best?



In Solidarity for the Future

KRYSTIAN KOGUT

board member
of the INTERMARIUM Foundation

There are plenty of interesting facts about Poland and many breathtaking things to see and experience here. It is worth knowing that Poland is the most populous in the region and comes second (after Ukraine) in terms of territory. Most of the Polish territory is located on the North European Plain; though some highlands and mountains can also be found, especially in the southern part of the country.

Poland, as a state, was mentioned in written history more than 1000 years ago. Its identity, culture, and tradition have been shaped throughout its long history by Latin civilization, western Christianity (both of which draw from classical Greek philosophy), and fondness for the idea of freedom – both personal and national independence. Poland, after forming a unique commonwealth with Lithuania for a few centuries, was a European power. However, in the 18th century, a combination of various internal and external factors led to the collapse of this giant. This oasis of freedom lost its independence for 123 years, divided between

The person will always be the most important!

neighboring empires, and absolute monarchies: Austria, Prussia (Germany), and Russia. At least since then, the history of Poland became a struggle for freedom laden with numerous sacrifices. In recent months, Poland has been in the news not only because of the transfer of Robert Lewandowski but also because of the impressive support of the Polish people and the Polish state to Ukrainians and Ukraine, who faced a brutal attack by Russian Federation. The whole world (and Ukrainians themselves) was touched by the scale of grassroots initiatives and the openness of the hearts of Poles to their Ukrainian neighbors. This circumstance was an opportunity for the Polish nation to recall its dedication to the fight for freedom and principles of Christian morality.

The InterMarium company also joined this wonderful movement through the INTERMARIUM Foundation, founded by Natalia Witkowska-Cempel and Witold Aleksander Cempel, PhD in 2018 to cherish and support values described above. Supported by a financial donation from FlexSim Software Products, and InterMarium company, the INTERMARIUM Foundation made a donation to the Ukrainian defenders and launched a project "In Solidarity for the Future."

'In Solidarity for the Future' is addressed to young refugees and immigrants from former Soviet Union countries, especially Ukraine. The INTERMARIUM Foundation wants to create conditions for better adaptation and support young people (and their families, if it's necessary) in a new, foreign, environment. The project is aiming to facilitate building new friendships, discovering the Polish culture as well as tradition, common values, historical moments and figures. It can even help the participants with discovering themselves, their interests, and the direction they would like to go in with their lives. All of that is possible provided we remain "In Solidarity for the Future!"

The volunteers' goal is to build sincere relations, based on mutual trust with participants and between themselves. It is important to show these young people, especially in this time of radical, even brutal divisions, that the nations of Central and Eastern Europe have more in common than what divides us. It is achieved by organizing trips, visits to interesting places, lectures, meetings,

mentoring sessions, and many more activities, so there is no boredom. No matter whether the participants of the project find their permanent place in Poland, another country in our region, or they come back to their countries of origin, they will feel like home everywhere and they will feel united with their international friends.

If you share values founded on Christianity and Latin civilization, and you would like to support the idea of international cooperation within the Intermarium region, and at the same time, help refugees, become a volunteer or support the INTERMARIUM Foundation's "Solidarity for the Future" project by donating to:

Beneficiary name: Fundacja INTERMARIUM
Beneficiary address: Aleja Pokoju 1, floor 11/12, 31-548 Kraków, Poland
Bank account no:
PL 88 1950 0001 2006 0070 7951 0005
Bank name: BANK POLSKA KASA OPIEKI SA
SWIFT/BIC: PKOPPLPWXXX
Bank Country: Poland
Bank City: Warszawa
Payment title (description): "Solidarity for the Future" project



SimuLatte

In order not to exaggerate the seriousness of the content, our community members and enthusiasts are creating specially for you a column called "SimuLatte" with cartoon humor for coffee break entertainment

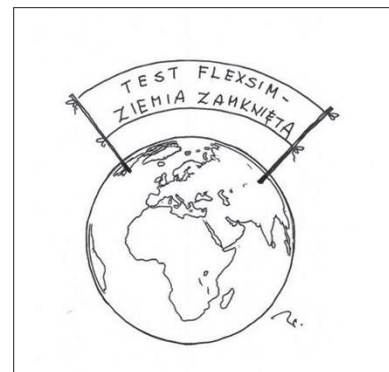
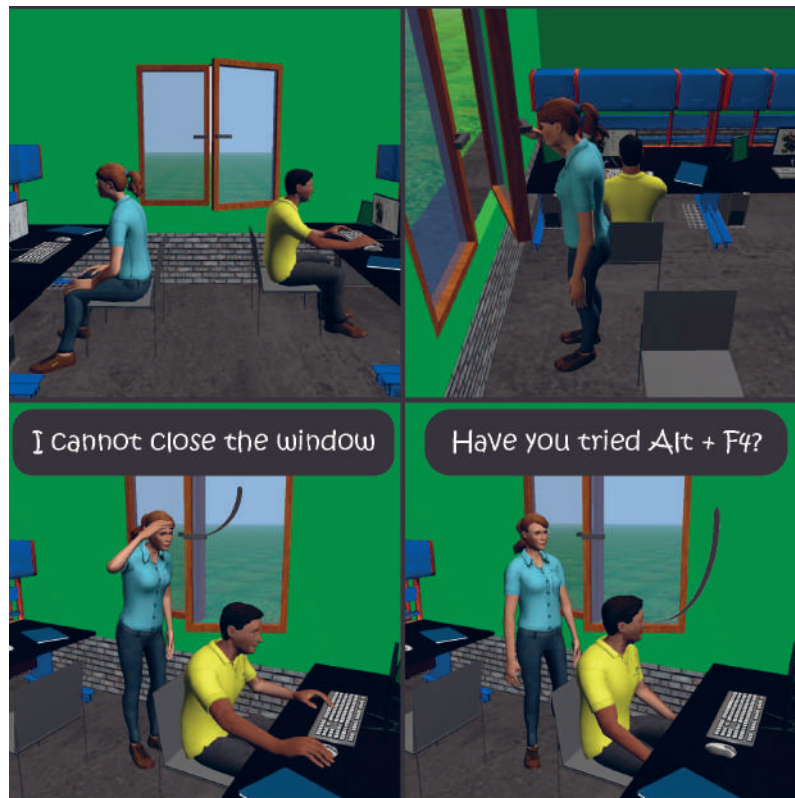
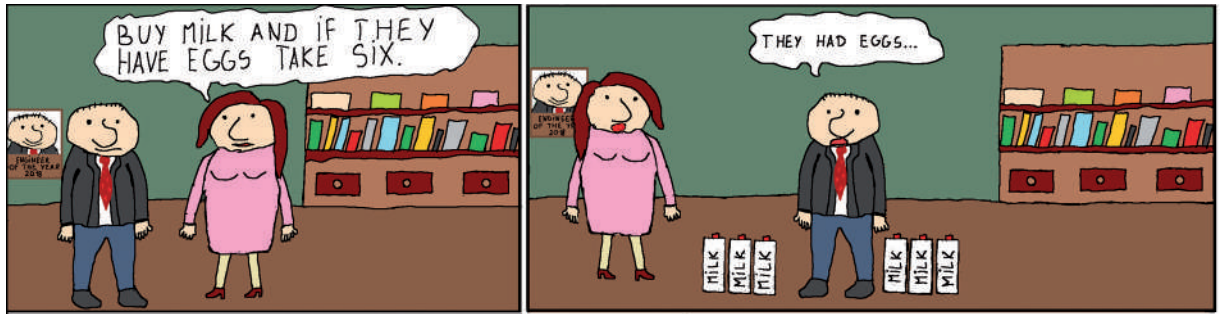

- Look, without FlexSim they are helpless...

SIMULATTE



Announcements

*There are many inspiring meetings and events ahead.
The coming year will be fruitful for the FlexSim community. We do not doubt it!*



Intermarium Simulation Conference 2022

Our activity this year will be culminated with the Intermarium Simulation Conference scheduled for September 29 2022.

The organizers of the Intermarium Simulation Conference intend to integrate the FlexSim user community in the Intermarium region. It will be a unique opportunity to meet many FlexSim users, FlexSim Intermarium customers and partners, as well as simulation experts and enthusiasts, all in one place. Representatives of FlexSim software developer, FlexSim Software Products, Inc., are expected as special guests. The event will allow participants to familiarize themselves with the latest trends in process simulation, get a chance to exchange experiences and establish new scientific, business or peer relationships.

May the Intermarium Simulation Conference become a permanent item in the calendar of our community!



Business missions - Central & Eastern Europe 2023

Part of the Intermarium team as "simulation

evangelists" will be heading to Romania in the second half of March 2023. Together with Effective Flux, Intermarium's local sales agent, we want to organize several conferences in different cities. Soon, we plan to organize similar missions in Greece and the Baltic States. The Intermarium delegation hopes to meet with current FlexSim software users, intends to visit selected customers, and through face-to-face meetings, help other companies and universities enter the world of FlexSim software simulation. We also hope to meet our dear readers on our tour. We will share our impressions of the trip in future issues of our Magazine.

Business Missions – Poland 2023

A series of stationary conferences titled "From Simulation Model to Digital Twin"

Discrete process simulation is not a new technology. For instance, FlexSim has been available on the global market for more than 20 years (and is actively developed to this day!). However, there are still a lot of companies in Poland that use conventional methods when analyzing and optimizing processes. During the conferences organized by Intermarium we present actual case studies of leveraging simulation. That way we strive for proving to all Participants in an accessible way that investment in simulation technology is a hit! After the success of the 4 conferences in the first half of 2022, as part of the Roadshow in Wrocław, Mielec, Gdańsk, and Łódź, at this point, we would like to announce that we will continue this formula

and expand it to other cities in the second half of 2022 and 2023. Wondering if your city will also be one of our destinations? Sign up for our newsletter and follow the news at flexsim.pl.

What can you expect at our conferences?

The agenda is as follows:

Knowledge, knowledge and once again knowledge.

Expert knowledge. You will learn what industrial process simulation is.

Case studies. You will learn about the outcomes of our projects.

Special guests. FlexSim users will present their own simulation findings.

Modern technology. You will test FlexSim in Virtual Reality.



Simulation project bureau

KRZYSZTOF JURCZYK

director of operations
at InterMarium LLC

FlexSim sets InterMarium apart from other providers of simulation software. Access to the inner workings of the program combined with a highly qualified and constantly developing staff make it possible for us to offer our clients the highest level of standard.

Don't speculate, simulate!

Our simulation project office provides process modeling and simulation bureau. Up until now, we have completed a formidable number of projects in areas such as:

1. warehousing:
 - (a) warehouse space dimensioning,
 - (b) number of internal logistics resources (forklifts, AGVs, ASRS),
 - (c) stock allocation,
 - (d) warehouse movement analysis (receipt, dispatch, picking, repacking);
2. production:
 - (a) workstation efficiency analysis,
 - (b) buffer capacity analysis,
 - (c) machine layout analysis,
 - (d) operator workload balancing;
3. automation:
 - (a) AGV loop design,
 - (a) conveyor system design,
 - (b) use of automated equipment (gantries, elevators, shuttles),
 - (d) robotic production and assembly lines;
4. simulation games:
 - (a) economic,
 - (b) related to the subject of Lean Management,
 - (c) others.

The outcome of our work can take the form of a recommendation for changes to the existing layout of machinery on the shop floor, an assessment of the appropriateness of machinery park choice, or an evaluation of the expected results of implementing specific warehouse procedures.

What makes us stand out?

We treat each project with due care and attention to detail. Although the tasks we undertake are diverse and varied, they can nevertheless be the basis for the subsequent implementation of FlexSim at the client's site. Therefore, all the knowledge it takes to complete a given project is readily shared with our clients. During training and workshops,

we encourage you to carry out simulation projects independently, preferably working on the data and logic of your own company (instead of some pre-worked unrelated examples) to help you kick-start the in-house modeling activities.

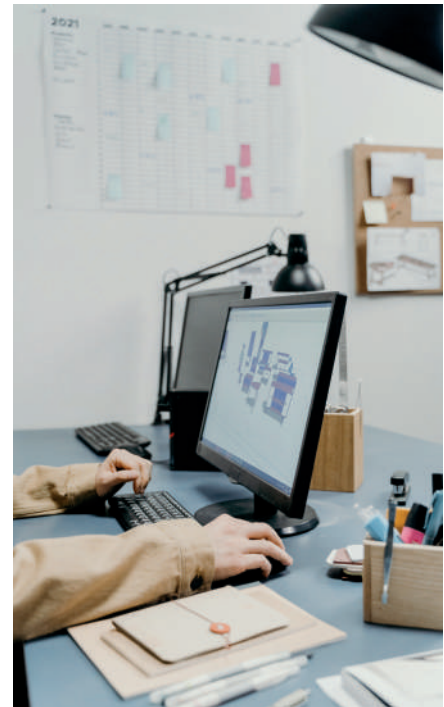

During such workshops we teach users more than just how to use the software and interpret the results obtained from a simulation. Above all, we take the opportunity to demonstrate to the executives that evaluating ideas does not have to be preceded by many unsuccessful attempts to initiate something new - we test bold decisions in the safe environment of a computer model. How many workers should I hire on the assembly line to meet the approved production plan? What happens if a customer increases their orders by 20% next week? Will it be possible to replace a piece of machinery with a new one without significant implications on fulfilling accepted orders? It is impossible to answer these questions using only a spreadsheet. In order to take full advantage of the opportunities offered by simulation software, we need to integrate it into the ongoing projects. This is not easy, so be sure to contact us and gain an edge over your competitors. Those who have trusted us repeatedly return with new topics. Dissatisfied customers... we don't have those.

FlexSim. User manual

KRZYSZTOF JURCZYK

director of operations
at InterMarium LLC

A practical guide of over 600 pages based on actual business cases that will help you build your own simulation models.

Let's build a simulation model of a system that processes orders according to the following guidelines:

The containers appear in the system according to the data contained in a given MS Excel file. Each container carrying the specified content appears in the corresponding part of the conveyor, and then it is transferred further towards the sorting line.

At the entry to the sorting line there is a photocell, the operation of which causes the transfer of the container to the available processing station. Containers which have not occupied an available processing station go around in a loop through the designated conveyor system, after which they are again transferred to the photocell.

container, meanwhile, remains stopped at a drop-off station.

The operator takes all the parts from the container, then deposits them on the buffer. After that they process each part individually on the table. The processed product is then placed back in the container.

The container with the packed processed contents is transferred to the output of the sorting line.

Does it sound familiar? It is the daily routine in the work of a production manager. You will learn how to model and analyze these types of systems by reading the manual we are publishing:

Krzysztof Jurczyk „FlexSim. Podręcznik użytkownika”.

It is more than 600 pages of practice and examples based on actual business cases. With the help of this manual, the reader can build a step-by-step model of the process of interest and acquire

We come to your aid. Process improvement simpler than you think!

An operator works at each processing station. They have a table on which they can process the contents of the container and a buffer on which they can deposit the finished parts. The empty

knowledge useful for modeling similar problems. The new guide for simulation modeling by Krzysztof Jurczyk is going to be available for purchase soon.



Simulation Academy – Simulation Project of the Year competition

KRYSTIAN KOGUT

international sales director
INTERMARIUM Foundation



InterMarium has launched a campaign targeting modelers, process engineers, graduates and students, giving those young, talented, committed and creative individuals a chance to develop their skills and receive a cash prize.

The idea standing behind this competition is to encourage innovative thinking among young people, promote using Flexsim simulation and support the growth of the general level of expertise in our distribution region. One of the means of

Lithuania, Moldova, Montenegro, North Macedonia, Poland, Romania, Serbia, Slovakia, Slovenia, and Ukraine. The project can be submitted by an individual or by a team.

How does it work?

It's good to start by reading "Rules and Guidelines" available on the Simulation Academy website (<https://intermarium.org.pl/en/simulation-academy/>) The participant has to register and

InterMarium invites you to take part in the competition of the Simulation Academy. Submit a simulation project of your own making and win 1 of the 3 prizes 1000 EUR each. The applications close at the end of the year

attaining these goals is rewarding and showcasing the work of the users who exhibit the highest standard of modeling. For many people, especially students, this could serve as an additional motivator to seriously consider entering the world of professional process simulation. This is why we are launching the Competition for the Best Simulation Project of the Year.

Who can participate?

Anyone! Or more strictly speaking, almost anyone since there is only one limitation that is geography. The invitation is directed to the users from countries where InterMarium operates as the exclusive FlexSim distributor, such as: Albania, Armenia, Azerbaijan, Belarus, Bosnia and Herzegovina, Bulgaria, Croatia, Cyprus, the Czech Republic, Estonia, Georgia, Greece, Hungary, Kosovo, Latvia,

only then is it time to log in and submit the project, making sure to meet all conditions and attach all required files. And that's it! However, instead of waiting idly, we recommend encouraging your friends to support your project in an open vote for the Audience Award.

Who chooses the winners?

There are 3 awards, and so there are 3 jury boards. Firstly, the highly respected academic professors and other lecturers from universities that use FlexSim, under the leadership of prof. Allen Greenwood (Professor emeritus of the Mississippi State University). They will award the selected project with Scientists Jury Award. Then, the Business Jury Award will be given out by the simulation experts, representing our business clients, under the leadership of Dawid Dąbal, Vice President,

FlexSim Program Director at InterMarium. Finally, everyone visiting the website of the competition will be able to vote for their favorite project. The highest-rated project will be awarded the Audience Award.

Is that all the winners can expect?

No, it's not! The winners will get an invitation to the award ceremony that will be a part of the

Intermarium Simulation Conference. It's a unique prize, because it gives the developers of the best projects a great opportunity to meet experienced FlexSim users, including representatives from business. The winners who are students can therefore meet their possible future employers. Moreover, the participants who do not win an award will still get a bit of spotlight. All the projects submitted to the competition will be published and freely

available on the competition website.

So, what are you waiting for? If you have made an impressive simulation model as part of your work, studies or research, submit it to the competition! And if you still haven't, then get working!

The participants who demonstrate the greatest innovation and novel perspective on the company and its products will get a chance to win alluring prizes and get an offer of a 6-months paid



Simulation games

KRZYSZTOF JURCZYK

director of operations
at InterMarium LLC

PATRYK ŻUCHOWICZ

senior simulation engineer
at InterMarium LLC



Among the latest products built using FlexSim are decision-making simulation games. The user takes on the role of a supervisor, manager or any sector employee - from an accountant to a farm owner - who makes various types of decisions, testing the effect they will cause. The player acquires the necessary knowledge and experience needed to take on similar challenges in the real world. They learn from their mistakes; however, these mistakes do not result in real problems such as production line downtimes, excessively high inventory levels

of defective products low. The customs officer at the border, on the other hand, will have to detect as much fraud as possible.

The academic staff use these games during their classes. The students learn the specifics of particular issues, gaining knowledge and experience that will pay off in the future when encountering similar problems in the real life.

As for the technical aspects, the game keeps track of the consequences of user's decisions. In addition, most of the events and parameters are de-

Learn from mistakes that have no consequences in real life

or even bankruptcy. These errors only "destroy" the virtual representation of the enterprise. Like in a classic computer game - we have many lives... The idea of simulation games was initiated with the delivery of a project for the Business Process Simulation Center at the Wrocław University of Economics and Business. As part of this transaction, the client ordered more than 20 simulation games from us, each of which deals with a different theme. As mentioned in the introduction - the user takes on different roles and has different tasks to complete. A player who is a warehouse manager has to minimize excessive inventory and at the same time ensure a sufficiently high level of fulfillment of orders from customers. In case of managing a production line, they will be interested in reducing downtime and keeping the proportion

scribed by probability distributions, thanks to which each game is different - the disruptive situations, like for example the breakdown of machinery and equipment, the absence of an employee or the introduction of a new tax by the country to which we import our goods is random. The user can dynamically react to such changes and witness the consequences of their decisions.

It is worth noting that simulation games do not need to be limited to the forms we know from classic computer games. FlexSim's compatibility with VR technology makes it possible to immerse yourself in the virtual reality of the aforementioned games - thus finding yourself standing in a warehouse or at a flight controller's station. Our "presence" in the game allows us to witness firsthand whether what we assume is physically possible.



Fig. 1. Screenshot from a simulation game about optimizing flows in a large-format home improvement store.

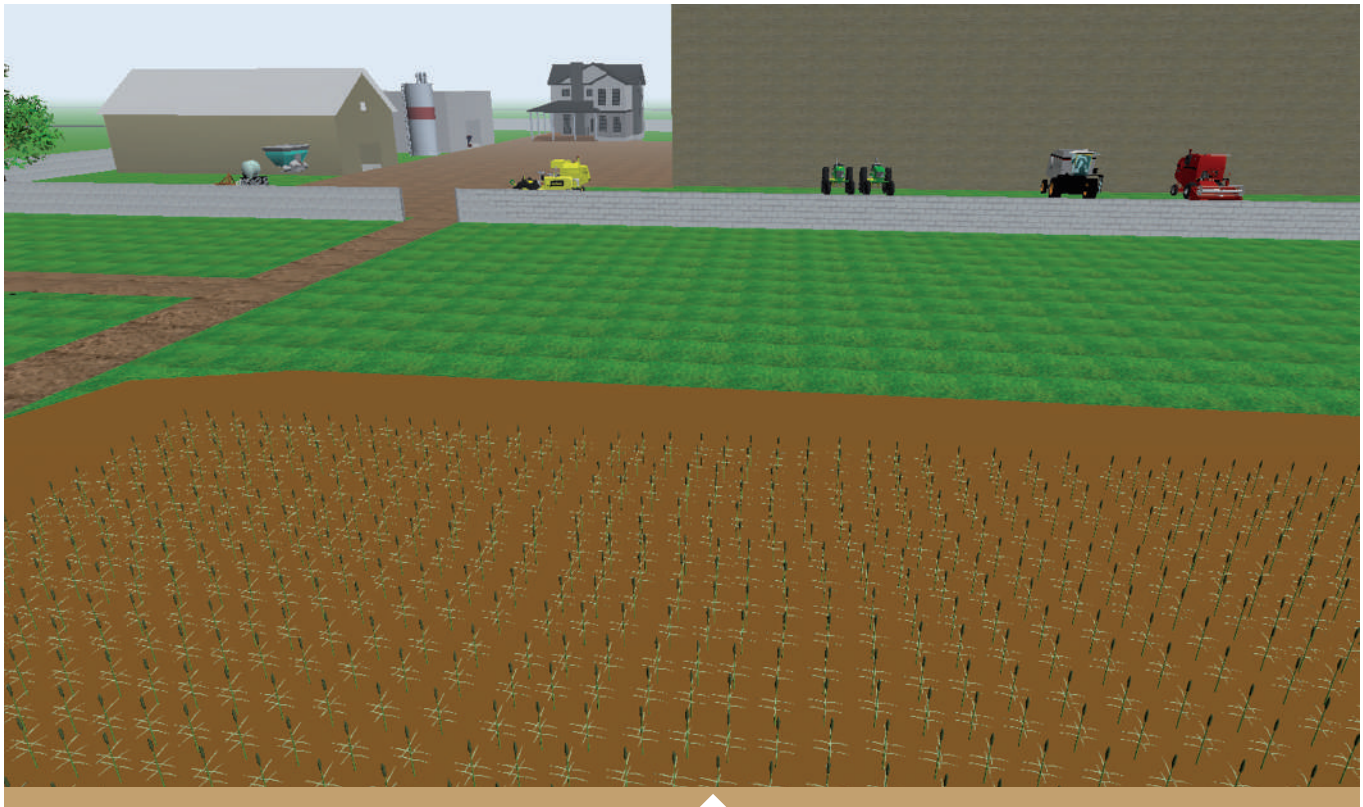

Fig. 2. Screenshot from a simulation game about the efficiency of the agricultural land development process .



Fig. 3. Screenshot from a simulation game about optimizing a manufacturing process .

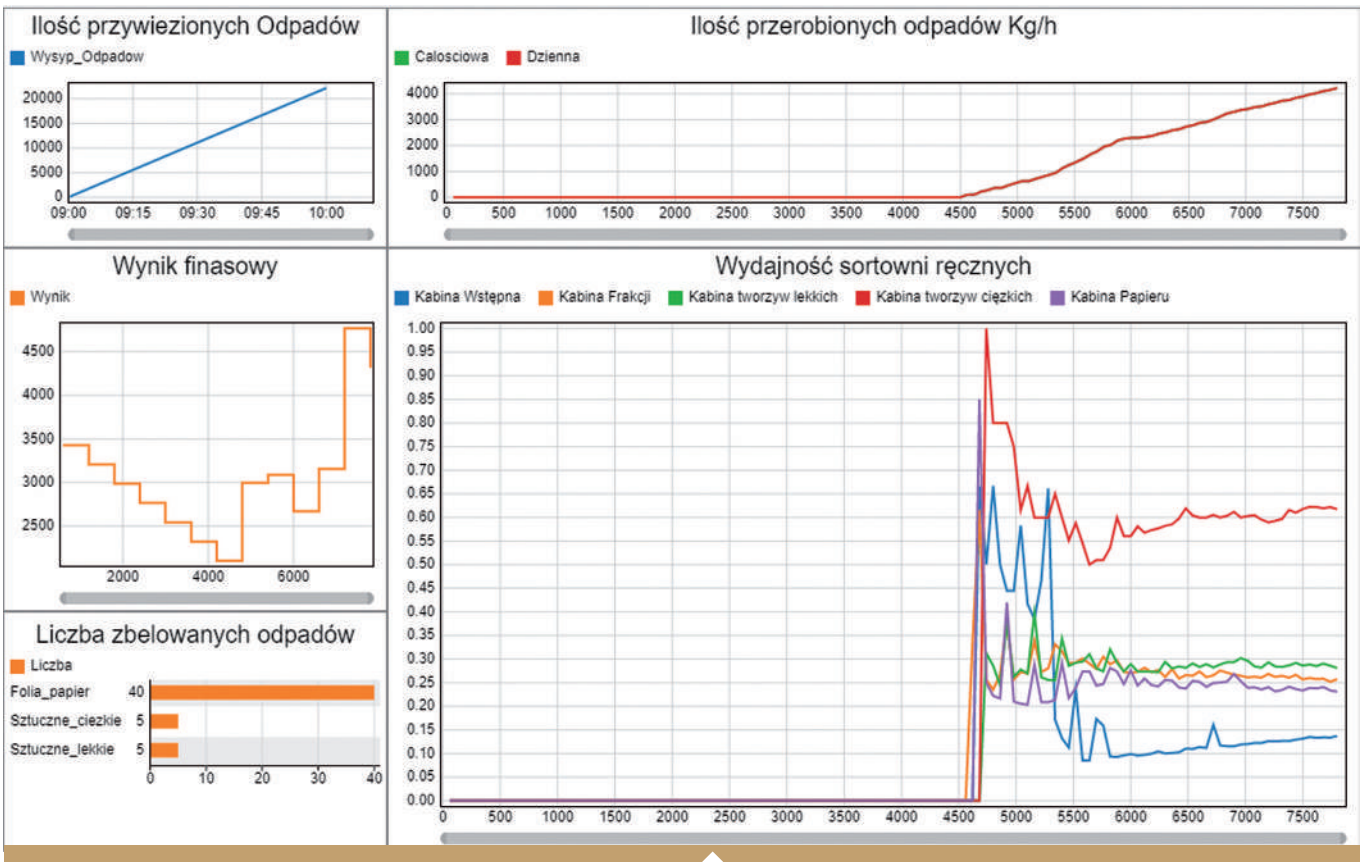

Fig. 4. Statistics window of the simulation game about the improvement of processes carried out in the waste sorting plant.



LIST OF PHOTOS:

COVER

1. Krzysztof Nowosielski
2. Pexels-tara-winstead-8386440
3. Pexels-linkedin-sales-navigator-1251848
4. iStock-1194430861

CONTENT

1. Pexels-andrea-piacquadio-3769135
2. Pexels-anete-lusina-4790267
3. Pexels-cottonbro-7430340
4. Pexels-nothing-ahead-70596605
5. Pexels-cottonbro-7504611
6. Pexels-cottonbro-3205736
7. Pexels-rodnae-productions-7648031
8. Pexels-pixabay-326576
9. Pexels-adi-goldenstein-2871506 (p. 11)
10. Pexels-vlada-karpovich-7433839 (p. 13)
11. Pexels-iStockphoto-1370204491 (p. 14)
12. Pexels-iStock-90825548 (p. 19)
13. Pexels-iStock-12075770 (p. 22)
14. Pexels-mikhail-nilov-6592644 (p. 26)
15. Pexels-mikhail-nilov-7988207 (p. 29)
16. AdobeStock-51873410 (p. 31)
17. Drawing by Zbigniew Polit (p. 32)
18. Drawing by Rafał Cempel (p. 32)
19. Drawing by Przemysław Pasich (p. 32)
20. Pexels-rodnae-production-7648031 (p. 33)
21. Pexels-cottonbro-6814524 (p.34)
22. Pexel-cottonbro-7504611 (p. 35)
23. iStock-1263629792 (p. 36)
24. Pixels-thisisengineering-3861969 (p. 37)
25. Pixels-nataliya-vaitkevich-6668811 (p. 38)
26. Pixels-olia-danilevich-5309570 (p. 39)
27. Pexels-federico-orlandi-3260626 (p.42)

Simulation project

bureau



FlexSim

InterMarium



digital twin

production

logistics

optimization

simulation games

Don't speculate, simulate!

Request a free consultation

www.flexsim.pl

simulation@flexsim.pl

+48 533 322 720



Production process engineering

Postgraduate Program

Acquire new skills and develop your competencies

The program is directed to future:

**production engineers
process engineers
production managers
production plant managers**

FIND OUT MORE:



**With the possibility of completing the program 100% online
Convenient form of study for those who can't or don't want to attend full-time classes**